

Healthcare Equipment & Parts #1800



We're The Friendly People

Serving Your Needs
Since 1974



Compare & Save Lowest Pricing Around



Bathroom and Shower Page 1



Drive 3 Position Recliners
See page 79 for Product Details
Sale \$369.01



Seating Page 77



AS LOW AS
\$132.97

Drive Medical
Silver Sport 2 Wheelchair
See page 32 for Product Details

Wheelchairs Page 31



SALE
SAVE 20%

Basic Alarm w/ Choice of Pad
See page 48 for Product Details

AS LOW AS
\$49.82



\$296.78

Quadro Cushion

See page 58 for Product Details

Wheelchair Accessories Page 39



Walking Aids Page 65



Therapy Page 145



Diagnostics Page 132



Free Basic Ocelco Exit Alarm when you purchase a
6 Pack of Sensor Pads, a **\$40.00 Savings**

Universal 45 Day Chair Exit Alarm Sensor Pad, 6 Pack
305-468-CHF \$99.99 Sale \$79.99

See page 49 for Product Details
Offer not valid with any other promotion

Patient Room Page 84



NEW

\$64.95

New Quiet Pill Crusher
See page 154 for Product Details

Pill Management Page 154

Aids to Daily Living

Dressing Aids	153
Kitchen Aids	151
Living Accessories	152
Medication Aids	154-156
Pill Crushers	154
Pill Ejector	155
Pill Splitter	156
Reachers	152
Utensils	151

Bathroom and Shower

Anti-Slip	27
Bariatric Commodes	17, 24-25
Bariatric Shower Chairs	16-17
Bedside Bathing	28
Commodes	22-23
Grab Bars	1-7
PVC Commode Chairs	18-21
PVC Gurneys	26
PVC Shower Chairs	18-21
Raised Toilet Seats	8
Safety Rails	5-7
Shower Chairs/Benches	10-13
Shower/Commode Chairs	15
Shower Curtains	30
Shower Sprayers	29
Toilet Grab Bars	2-7
Toilet Seat Cushions	9
Transfer Benches	12-14
Transfer Systems	14

Carts

Carts	129-131
Chart Rack Carts	131
Hampers	128
Laundry Cart	128
Linen Carts	129

Diagnostics

Blood Pressure Monitors	142
Disp. Sphygmomanometers	139
Pulse Oximeters	143
Sphygmomanometers	136-142
Sphygmomanometer Parts	140-141
Stethoscopes	132-133
Stethoscope Parts	134-135
Thermometers	144

Gloves

Gloves	144
Glove Box Holders	144

Patient Room

Air Mattress Systems	95-97
Bariatric Beds	88
Bed Controls	89
Bed Exit Alarms	106-109
Bed Rails	98-101
Bed Rail Pads	103
Call Cords and Clips	90
Curtains	122-123
Curtain Tracking	124-125
Exam Room	111
Fall Prevention	106-109
Foam Mattresses	93-95
Foot Stools	111
Foot Supports	103
I.V. Systems	112
Low Beds	86-87
Mattresses	92-94, 97
Mattress Covers	92
Mattress Overlays	94-96
Mayo Stand	111
Pads and Positioners	97,103,105
Patient Lifts	114-117
Patient Lifter Accessories	117
Patient Lifter Scales	117
Patient Lifter Slings	118-121
Pillows	104-105
Privacy Screens	122
PVC Low Beds	86
Standard Beds	84-85
Super Poles	102
Transfer Systems	91
Trapeze Equipment	113
Trays and Tables	110-111

Respiratory

CPAP's	150
Oxygen Regulators	149
Oxygen Tanks/Accessories	148-149

Scales

Bariatric Scales	127
Chair Scales	126
Digital Scales	126-127
Physician Scales	126
Wheelchair Scales	127

Seating

Geri-Chairs	78
Hip Chair	77
PVC Recliners	78
Recliners	78-83
Uplift Seat Assists	77

Therapy

Heat Therapy	145
MediBeads	145
Physical Therapy	145
Tens Units / Accessories	146-147
Therabath	145

Walking Aids

Bariatric Walkers	71
Canes	66
Crutches	65
Crutch Accessories	65
Forearm Attachment	76
Knee Walker	67
Merry Walkers	75
PVC Walkers	74-75
Rollators	72-73
Specialty Walkers	67
Walkers	67-71
Walker Accessories	69-70,76
Walker Glides	69, 76

Wheelchairs

Bariatric Transport Chair	31
Bariatric Wheelchairs	36-37
Reclining Wheelchairs	38
Standard Wheelchairs	32-35
Transport Chairs	31

Wheelchair Accessories

Accessories	53
Adaptive Seating	59-64
Adaptive Seating Hardware	64
Anti-Rollback Device	47
Anti-Theft Bar	40
Anti-Tippers	39-40
Brake Extensions	41
Cup Holders	53
Cushions	53-58
Drainage Bags	51
Eggcrate Overlays	53
Fall Monitors	46-49
Headrest Extensions	50
I.V./Oxygen Holders	41
Lap Huggers	52
Ramps	45
Safety Belts	42-43
Solid Backs	59
Solid Seats	60-61
Transfer Systems	44
Wheelchair Pouches	50
Wheelchair Trays	52

White Powder Coated Grab Bar

Features:

- › Heavy-duty steel construction
- › Large 3-hole welded flanges provide additional security
- › Mounts vertically or horizontally
- › 1½" distance from the wall
- › 1" in diameter

Grab Bar

12"	220-220	\$13.13
16"	220-221	\$14.27
18"	220-222	\$14.88
24"	220-223	\$16.35
32"	220-224	\$16.42



Chrome, Knurled Grab Bar

Features:

- › Durable, chrome-plated steel is attractive and easy to clean
- › Knurling around the grab bar diameter provides a no-slip grip
- › Mounts vertically or horizontally
- › 1½" distance from the wall
- › 1" in diameter

Grab Bar

12"	220-226	\$14.90
16"	220-227	\$16.15
18"	220-228	\$25.95
24"	220-229	\$19.02
32"	220-230	\$21.90



Suction Cup Grab Bar

Features:

- › Installs and removes without tools or professional installation.
- › Can be installed at any angle.
- › Will not damage property.
- › Large suction cups provide an extremely strong hold.
- › Release levers make installing and removing the suction-cup grab bars quick and easy.



Adjustable Grab Bar

Features:

- › Installs and removes without tools or professional installation.
- › Will not damage property.
- › Large suction cups provide an extremely strong hold.
- › Release levers make installing and removing the suction cup grab bars quick and easy.



Suction Cup Grab Bar

12"	220-328	\$12.32
-----	----------------	----------------

Adjustable Suction Cup Grab Bar

19 3/4"	220-219	\$19.45
---------	----------------	----------------

All Grab Bars are made with stainless steel and come in 1½" diameter. Other diameters are available in 1¼" and 1" but may not meet building or state codes. All Grab Bars have 14 gauge thick, 3" diameter ends. Strong yet flexes slightly during installation to reduce the possibility of tile cracking. 1½" space between wall and grab bar. ADA approved.

Shipping: Some items are too large to ship UPS and must go truck, these items are marked with this symbol.



Options Available at an Extra Charge, please call for price.

Peened: texture is achieved with metallic balls shot with high pressure air jet on the surface of the metal, which produces slight indentations.

Anti-Slip: is a non-slip coating applied to the surface of the bar.

Basic Straight Bar

Grab Bar

12"	220-114	\$25.83
16"	220-119	\$27.50
18"	220-113	\$28.28
24"	220-112	\$33.30
30"	220-111	\$36.05
32"	220-120	\$33.38
36"	220-110	\$35.05
42"	220-109	\$37.80
48"	220-108	\$40.25
52"	220-122	\$48.80
54"	220-123	\$51.58



Straight Bar with Mid Support

Grab Bar

36"	220-206	\$59.53
42"	220-205	\$62.45
48"	220-204	\$71.58
52"	220-207	\$71.28
54"	220-208	\$77.62
60"	220-209	\$71.56
72"	220-210	\$91.80
84"	220-211	\$101.25
96"	220-212	\$108.00
108"	220-213	\$126.26



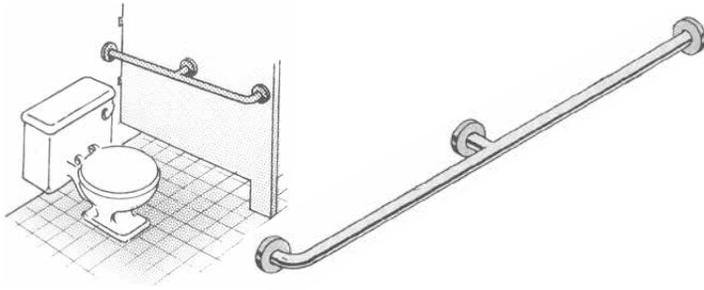

Straight Bar with Corner Mount

Two-wall attachment gives this bar extra support.

Grab Bar

42"	220-214	\$58.28
48"	220-215	\$62.22
52"	220-216	\$66.15
54"	220-217	\$66.93

Horizontal Corner Bar

This useful bar provides gripping surface on two walls. May be mounted either left or right.

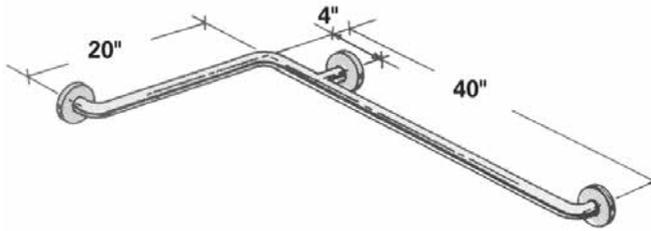

Grab Bars

16"x31"	220-415	\$75.60
24"x24"	220-416	\$75.60
20"x40"	220-414	\$74.93
24"x36"	220-417	\$74.93
36"x48"	220-418	\$96.84
36"x52"	220-419	\$90.46
36"x54"	220-420	\$101.29

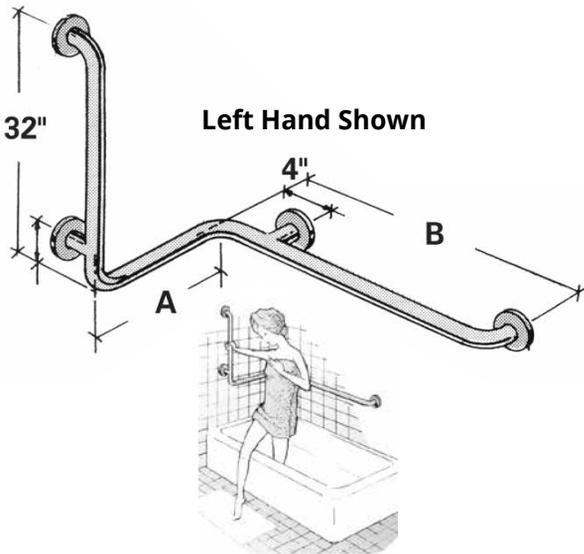

Tub/Shower Horizontal Corner Bar with Vertical Arm

These bars are excellent multi-purpose bars that provide a vertical arm and two horizontal supports for added stability. When entering tub, if the bather's right hand grips the vertical, specify right. If reverse, specify left.

Grab Bars

Right Side, A=24" B=24"	220-454	\$116.77
Left Side, A=24" B=24"	220-455	\$116.77
Right Side, A=20" B=40"	220-452	\$118.13
Left Side, A=20" B=40"	220-453	\$118.13
Right Side, A=24" B=48"	220-412	\$124.20
Left Side, A=24" B=48"	220-413	\$124.20

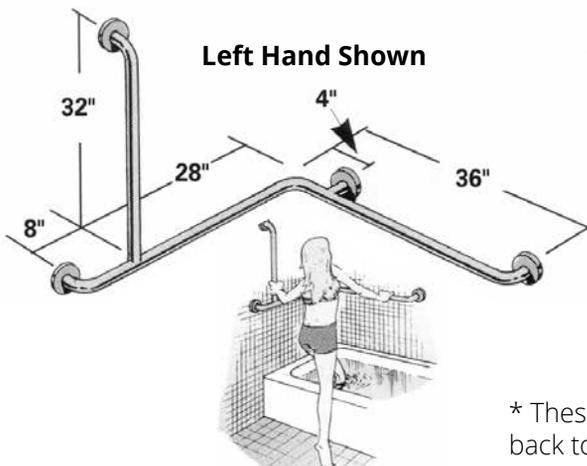

Tub/Shower Horizontal Corner Bar with Offset Vertical Arm

These bars are excellent multi-purpose bars that provide a vertical arm and two horizontal supports for added stability. When entering tub, if the bather's right hand grips the vertical, specify right. If reverse, specify left.

Grab Bars

Right Side	220-456	\$141.76
Left Side	220-457	\$141.76
Right Side	220-456-S*	\$201.43
Left Side	220-457-S*	\$162.89



* These bars will be shipped as 2 or more pieces that can be spliced back together. This allows it to be shipped UPS rather than by Truck.

Inclined Bar

When this bar is mounted at a 45° angle, the center line is designed to hit building studs 16" apart.

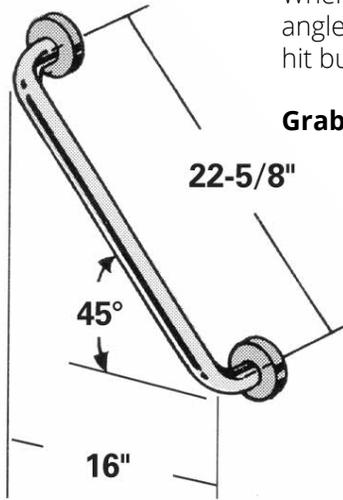

Grab Bar 220-427 \$40.95



Combination Grab Bar

Grab Bar 220-426 \$75.60

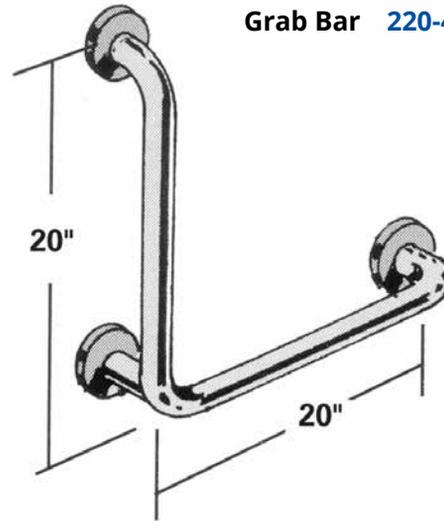

Boomerang Bar

Grab Bar 220-405 \$62.10

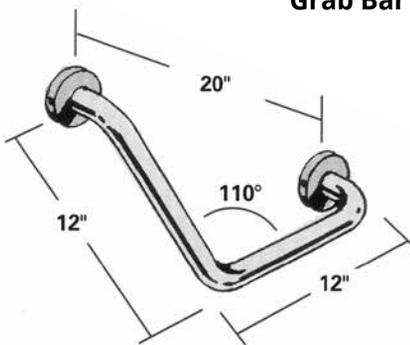

Hockey Stick

Left and right determined by standing in front of stool.

Grab Bars \$67.73
 Right **220-425**
 Left **220-424**

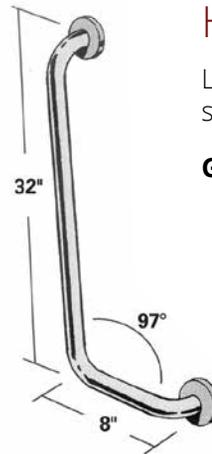

Left Hand Shown

Horizontal/Vertical Bar

Left and right determined by standing in front of tub. When entering tub, if the bather's right hand grips the vertical, specify right. If reverse, specify left.

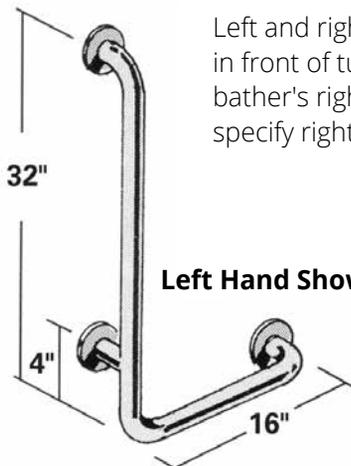

Left Hand Shown



Grab Bars

- Right, 12"x24" **220-307 \$70.88**
- Left, 12"x24" **220-311 \$70.88**
- Right, 16"x32" **220-303 \$76.38**
- Left, 16"x32" **220-304 \$76.38**
- Right, 18"x32" **220-308 \$77.97**
- Left, 18"x32" **220-312 \$77.97**
- Right, 24"x36" **220-309 \$72.23**
- Left, 24"x36" **220-313 \$80.25**
- Right, 24"x48" **220-310 \$79.66**
- Left, 24"x48" **220-314 \$87.23**

Wall to Floor Bar with 4" Extension

Provides the same function as #220-402 without outrigger at floor; however the bar requires a 4" extension set into a concrete floor.

Grab Bar 220-407 \$81.08

Wall to Floor Bar with Outrigger

Surface mounted bar utilizes outrigger at floor to stabilize. Left and right determined by standing in front of stool.

Grab Bars \$93.89
Right **220-403**
Left **220-402**

Left Hand Shown

Wall to Floor Bar

Exceptionally sturdy design allows surface mounting without outrigger or extension. Stainless steel tubing and chrome plated brass cover flanges slip over steel liners attached to wall and floor.

Grab Bar 220-406 \$137.39

Adjustable Nylon Disk

Tub Entry Bar

This bar provides a convenient grip for balance at tub entrance. The time-tested design combines floor mounting and adjustable tub brace. 1" diameter tubing.

Dimensions are for 16" tub height. If different, please give tub height from the floor.

Entry Bar 220-458 \$131.80

Floor/Corner Mounted Tub Bar

SHIPS BY TRUCK

Left and right determined by standing in front of tub.

Grab Bar
Right **220-408 \$93.16**
Left **220-409 \$93.16**
Right **220-408-S* \$128.26**
Left **220-409-S* \$128.26**

* These bars will be shipped as 2 or more pieces that can be spliced back together. This allows it to be shipped UPS rather than by Truck.

Left Hand Shown

Wall Suspended Tub Bar

Grab Bars
36" **220-451 \$127.57**
40" **220-411 \$226.92**

Floor Mounted Tub Bar

SHIPS BY TRUCK

Grab Bars
36" **220-450 \$139.73**
36" **220-450-S* \$147.87**

* These bars will be shipped as 2 or more pieces that can be spliced back together. This allows it to be shipped UPS rather than by Truck.

Straddle Bar

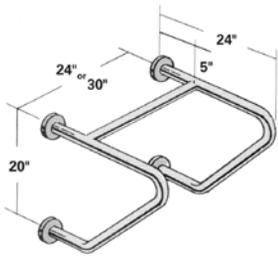

Grab Bars

- 24" **220-404 \$179.99**
- 30" **220-445 \$168.61**

Straddle Bar for Flush Valve

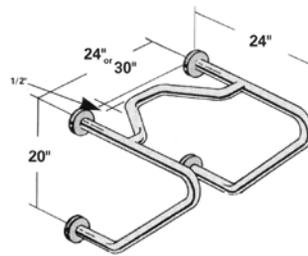

Grab Bars

- 24" **220-430 \$151.70**
- 30" **220-431 \$182.04**

Straddle Bar for Tank Toilet

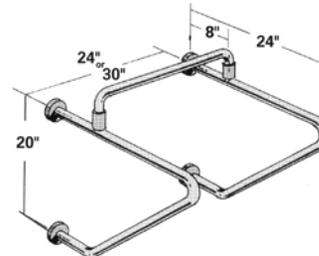

Grab Bars

- 24" **220-432 \$165.38**
- 30" **220-433 \$198.45**

The crossbar is attached to the parallel bars at the jobsite with epoxy, included.

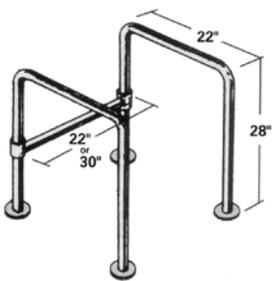

Floor Mounted Straddle Bar

The crossbar is vertically adjustable.

Grab Bars

- 22" **220-428 \$169.54**
- 30" **220-429 \$221.14**

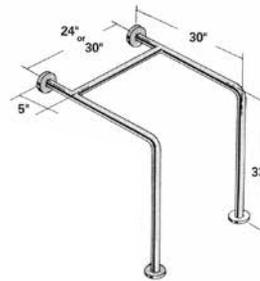

Wall to Floor Straddle Bar

Grab Bars

- 24" **220-401 \$164.75**
- 30" **220-444 \$197.71**



The WingIt™

The Worlds Strongest Fastener for Grab Bars. Allows for Installation of Grab Bars into Almost Any Wall!

The WingIt™ can reduce the cost of retrofitting a grab bar up to 70% while allowing for freedom of placement in both new and existing construction. Dry wall, tile, and acrylic or fiberglass tub surrounds are some of the walls that the WingIt™ can be utilized. Freedom of design: WingIts™ allow for grab bar installation to occur at any time during the building process. Architectural changes or lack of communication between the building trades will not affect the grab bar installation process. There is not any reinforcement to miss, installation of the WingIts™ can be done after the bathroom fixturing has been set.

Features:

- › Waterproof seal - Incorporates 3M® VHB Tape
- › No blocking or studs needed
- › No need to tear open and reconstruct walls
- › Can be installed in all framed walls
- › In sheet rock and ceramic tile, WingIts hold up to 1000lbs.
- › Meet and exceed all building codes and ADA Requirements
- › Only legal alternative to 2x10 blocking

WingIts™



WingIt with screw backed out.



WingIt installed and tightened down.

WingIt Installation needs

- WingIt, specify 4" long screw or **220-232 \$30.00**
- 5" long screw or **220-232-05 \$32.00**

Over 400 lbs.,
 swinging from a grab bar
 installed into 1/2" sheet
 rock and ceramic wall
 tile with the WingIt
 Fastening System.
**WingIts Hold Up
 To 1,000 lbs.**



For use with grab bars on preceding pages or where specified. Special flanges are needed (no charge).



Tub Safety Rail

Specifications:

Clamp: 3½" to 5½"
Weight Capacity: 300 lbs.

Safety Rail

8"x11" **224-100 \$23.25**



Hi-Lo Bar

Specifications:

Dimensions: 16"x14¾"
Weight Capacity: 250 lbs.

Hi-Lo Bar 224-101 \$30.00



Plastic Tub Rail

Specifications:

Height Above Tub: 12"
Width: 6"
Length: 7¾"
Clamps: 2½" to 6½"

Safety Rail

224-102 \$32.11



Clamp on Tub Rail

Specifications:

Height Above Tub: 14¾"
Clamps: 3" to 7"

Safety Rail 224-104 \$29.91



Heavy-Duty Bathtub Safety Rail



Features:

- › Unique design provides a good gripping surface from any direction
- › Not recommended for use with fiberglass tubs
- › White in color

Safety Rail 224-105 \$29.95



Clamp On Adjustable Tub Rail



Features:

- › Easy tool-free assembly
- › Height adjusts from 14" to 17"
- › Integrated dishes for soap and shampoo
- › Soft cover for added safety
- › Turn knob for easy adjustment
- › Oversized handle provides additional stability, making bathing safe and secure

Clamp On Tub Rail 224-115 \$82.78

Extend A Hand



Extend A Hand is a product that rewards the individuals with added safety and stability. This product is used in "at-risk to fall" areas in your home. Falls in the home cause additional medical expense and are a main reason for people to seek assisted living alternatives. Extend A Hand is preferred for assistance in maneuvering through a "at-risk-to-fall" area of your home, cottage, boat, garage, RV or hot tub area. Extend A Hand folds out and locks 12" from the wall, plus between the locking extension is a conventional grab bar. With Extend A Hand engaged this grab bar is easier to reach. This product will give you added safety for maneuvering in and out of the bathtub. Once inside you can still use the Extend A Hand for balance assistance while showering. If you don't need the extension it folds down out of the way. Extend A Hand is made with powder coated aluminum and all stainless steel mounting hardware. The rust free materials allow it to be mounted in shower or hot tub areas. Extend A Hand can withstand over 600 lbs. of sustained weight directly on the 12" easy lift auto-locking extension armature.

Extend A Hand is ADA & ADAAG compliant. It has passed NAHB testing for ASTM F446-93. Extend A Hand is a DME Medicare registered device.

White

16"x12" **220-463 \$126.00**
24"x12" **220-467 \$134.67**

Stainless Steel

16"x12" **220-464 \$141.38**
24"x12" **220-468 \$151.25**
32"x12" **220-466 \$169.64**

Toilet Safety Frame

Features:

- › Anodized aluminum is sturdy and lightweight
- › Powder coated aluminum bracket easily attaches frame to toilet
- › Arm height and width are adjustable

Specifications:

Between Arms: 18" to 25"
 Height to Arms: 27" to 31"
 Weight Capacity: 300 lbs.



Deluxe Toilet Safety Rails

Specifications:

Between Arms: 18" to 24"
 Armrest to Floor: 26" to 31"

Grab Bar

222-300 \$39.50 pr.



Grab Bar 222-100 \$26.75

Toilet Bars

Features:

- › Plastic armrests
- › 1" in diameter
- › Detachable for easy cleaning

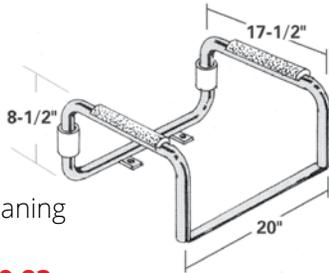

Grab Bar 220-421 \$149.83

Wheelchair Toilet Bar

Extra wide legs for easy access by wheelchair users. The #220-422 mounts to the floor and the #220-423 tilts up for easy cleaning. Both bars fit toilet bowl heights of 15" to 15½", but can be modified to fit your requirements.



Grab Bars

Toilet Bar

220-422

\$166.00

Tilt-Up Toilet Bar

220-423

\$190.53

Swing-Away Bar

Bar swings out of way when not in use. A simple lifting motion allows user to lock arm securely in any of three positions 90° apart. To eliminate maintenance and repairs, no springs are used.

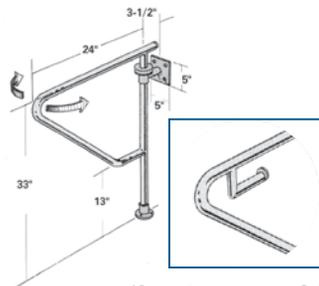

Toilet Paper Holder

Grab Bar

Swing-Away Bar

220-462

\$226.75

Swing-Away Bar with

220-461

\$225.07

Toilet Paper Holder

Swing-Up Bar

Bar swings up out of the way when not in use and is lowered into position when needed. The bar moves smoothly and easily due to adjustable tension in the hinge which also prevents it from free falling.

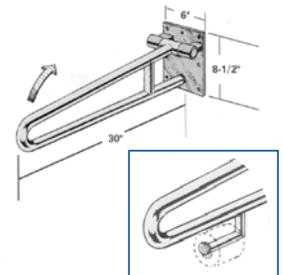

Toilet Paper Holder

Grab Bar

Swing-Up Bar

220-460

\$196.46

Swing-Up Bar with

220-459

\$214.61

Toilet Paper Holder

P.T. Rail

Fixed wall mounted rail with an exceptionally solid feel and an innovative offset rail design. Finally, a double rail that makes sense and provides maximum hand and wrist comfort. Has a weight capacity of 350 lbs.

Swing-Up P.T. Rail

Left Side

220-469-L \$174.85

Right Side

220-469-R \$174.85



Offset Dual Rail

Clip-On Toilet Paper Holder

Snap this paper holder on to the frame of a commode or handrail around an elevated toilet seat. May be locked in place with rubber retainer rings or left to snap on and off.

Toilet Paper Holder

220-481

\$16.95



Molded Raised Seat with Hand Grips



Specifications:

Raised Height: 5"
 Seat Width: 15½"
 Seat Depth: 16"

Raised Toilet Seat
225-102 \$19.95

Economy Raised Toilet Seat



Specifications:

Raised Height: 4½"
 Seat Width: 15"
 Seat Depth: 15"

Raised Toilet Seat
225-111 \$15.95

Padded Raised Seat



Features:

Soft, Padded Toilet Seat Riser
 Attaches with Hook & Loop Straps
 Covered with Easy to Clean Vinyl
 Choose 2" or 4" thickness below

Padded Raised Toilet Seats
 2" Thick **225-141-02 \$16.58**
 4" Thick **225-141-04 \$24.92**

Lock-On Raised Toilet Seats



Specifications:

Raised Height: 5"
 Arm Height: 4½"
 Between Arms: 19"
 Seat Width: 16"
 Seat Depth: 17"

Raised Toilet Seats
 Without Arms **225-117 \$39.25**
 With Arms **225-118 \$56.42**

Locktight Raised Seat with Aluminum Arms



Specifications:

Raised Height: 5"
 Arm Height: 7½"
 Between Arms: 18"
 Seat Width: 15½"
 Seat Depth: 17"

Raised Toilet Seat
225-124 \$37.48



Specifications:

- › Fits most toilets
- › Full length padded removable arms
- › Heavy-duty molded plastic construction provides strength and durability
- › Improved locking device is engineered with a heavy-duty screw and locking plate to ensure a safe, secure fit

Toilet Seat with Handle
225-125 \$34.59

Premium Toilet Seat with Handle

Premium Seat Riser



Specifications:

Seat Width: 14"
 Seat Depth: 17"
 Seat Height: 3½"
 Between Arms: 19"
 Weight Capacity: 300 lbs.

Standard Toilet Seat \$61.85
 Standard Toilet **225-119**
Elongated Toilet Seat \$73.70
 Elongated Toilet **225-120**

Versa Height Raised Toilet Seat



Specifications:

Seat Width: 14¾"
 Seat Depth: 15½"
 Seat Height: 3¾" to 5¾"
 Weight Capacity: 300 lbs.

Raised Toilet Seats
 4 Clip-on Brackets **225-105 \$38.33**
 2 Clip-on and 2 Locking Brackets **225-106 \$40.42**



Toilevator

The discreet design fits under the existing toilet base, raising the entire toilet 3 1/2". Unlike traditional raised toilet seats, the Toilevator is an easy one time installation with no special cleaning or maintenance required. It comes in standard white in color, but you can custom paint it to match your bathroom decor.

Features:

- › Easy to clean
- › Blends into the bathroom decor
- › Comfortable and secure
- › ADA compliant and meets all building codes
- › Easy to install, complete kit
- › Creates a safe, stable raised toilet for use by the whole family
- › Ideal for home, healthcare, commercial and institutional use

Specifications:

Dimensions: 11 1/2"x24"
 Total Height: 3 1/2"
 Weight Capacity: 500 lbs.



Toilevator

225-121 \$108.57

Akros® D.F.D. Commode Cushion

Features:

- › Combination gel-foam cushion provides pressure relief while toileting
- › Ideal for patients who use toilets, bed pans or commodes for extended periods
- › Cover is made of Sure-Check® anti-microbial fabric
- › Submersible version is excellent for use with bath benches and shower chairs
- › 17"x16"x1"
- › Weight Capacity: 250 lbs.



Commode Cushions

Standard **221-101 \$81.67**
 Submersible **221-102 \$88.33**

Roho Toilet Seat Cushion

The Toilet Seat cushion is designed for standard size toilets and portable bedside commodes. Maximizes stability of the user while protecting from a potential risk of tissue breakdown. Positions the body securely.



Toilet Seat Cushion

707-512 \$209.21

Portable Bathtub Bench



Bathtub Bench
224-220 **\$52.27**

One-piece bathtub bench adds convenience, comfort and safety to the bathroom. It is portable for easy storage and travel. Handle provides additional safety and stability for the user. Rubber stops help protect tub from scratches.

Round Shower/Bath Stool



Specifications:
Seat Height: 15¼" to 19¼"
Seat Diameter: 13"
Weight Capacity: 250 lbs.

Shower Stool
226-103 **\$27.95**



Adjustable Shower Seats

MICHAEL GRAVES
active living
COLLECTION™

Specifications:
Seat Height: 16.5" to 21.25"
Seat Width: 16"
Seat Depth: 16"
Weight Limit: 300 lbs.

Shower Seats
Seat **226-019-NB \$62.75**
Seat with Back **226-019 \$69.70**



Folding Bath Bench

Specifications:
Seat Height: 17" to 15½"
Seat Width: 20"
Seat Depth: 12"
Weight Limit: 300 lbs.

Bath Bench 226-147 **\$32.08**



Deluxe Bath Bench

Specifications:
Seat Height: 14" to 20"
Seat Width: 20"
Seat Depth: 12"
Weight Limit: 300 lbs.

Bath Bench
without Back **226-102 \$25.95**
with Back **226-101 \$29.95**



Deluxe Heavy Duty Bath Bench



Specifications:
Seat Height: 14" to 21"
Seat Width: 20"
Seat Depth: 12"
Weight Capacity: 500 lbs.

Heavy-Duty Bath Bench
without Back **226-150 \$51.25**
with Back **226-149 \$53.77**



Teak Adjustable-Height Shower Stool

Features:

- › Attractive high-quality teak is renowned for its durability and weathering properties.
- › Teak will naturally take on a silver gray patina after months of exposure to water.
- › Ideal for use in shower stall.
- › Ideal as a woman's grooming stool.
- › Easy, tool-free assembly.
- › Legs are lightweight, durable, and height adjustable in 1" increments.
- › Large rubber tips reduce slipping.

Teak Shower Stool **226-186 \$60.95**



Shower Chair with Arms and Replaceable Cut Out Seat

Specifications:

Seat Height:	16" to 20"	Armrest Height:	21½" to 25½"
Seat Size:	19"x14½"	Seat to Arm Top:	5½"
Base Width:	8½" to 19¼"	Width Between Arms:	18¾"
Base Depth:	18" to 20"	Weight Capacity:	350 lbs.



Shower Chair 226-837 **\$71.44**

Snap-n-Save Shower Chair with Arms

Specifications:

Seat Height:	16" to 20"	Armrest Height:	6"
Seat Size:	12¾"x18½"	Width Between Arms:	19"
Base Width:	18" to 18½"	Weight Capacity:	350 lbs.
Base Depth:	18" to 19¾"		



Shower Chair 226-823 **\$75**

Snap-n-Save Shower Chair with Arms and Back

Specifications:

Seat Height:	16" to 20"	Back Height:	13"
Seat Size:	12¾"x18½"	Armrest Height:	6"
Base Width:	18" to 18½"	Width between Arms:	20"
Base Depth:	18" to 19¾"	Weight Capacity:	350 lbs.



Shower Chair 226-826 **\$81.43 DISC.**

Heavy-Duty Snap-n-Save Shower Chair with Arms and Back

Specifications:

Seat Height:	16" to 20"	Armrest Height:	7¼"
Seat Size:	20½"x13½"	Width between Arms:	22½"
Base Width:	28" to 28¾"	Weight Capacity:	500 lbs.
Base Depth:	17" to 18½"		



Shower Chair 226-845 **\$121.43**



Padded Transfer Bench

Specifications:

Seat Height: 16¾" to 21¾"
 Seat Width: 25¼"
 Seat Depth: 16¼"
 Weight Limit: 300 lbs.



Transfer Bench 226-146 \$138.16



Composite Transfer Bench

Specifications:

Seat Height: 16" to 21"
 Seat Width: 30"
 Seat Depth: 15"
 Weight Limit: 350 lbs.

Transfer Bench 226-143 \$80.11

Plastic Transfer Bench



Specifications:

Seat Height: 18" to 22"
 Seat Width: 27"
 Seat Depth: 16"
 Weight Limit: 300 lbs.

Transfer Bench 226-110 \$64.34

Padded Transfer Bench



Specifications:

Seat Height: 18" to 21"
 Seat Width: 24"
 Seat Depth: 16"
 Weight Limit: 300 lbs.



Transfer Bench 226-108 \$89.95

Heavy-Duty Transfer Bench



Specifications

Seat Height: 16" to 20"
 Seat Width: 25½"
 Seat Depth: 18"
 Weight Limit: 500 lbs.



Transfer Bench 226-114 \$98.85



Deluxe Heavy-Duty Transfer Bench With Dual Frame Brace



Specifications:

Seat Height: 16" to 21"
 Seat Width: 27"
 Seat Depth: 16"
 Weight Limit: 600 lbs.

Transfer Bench 226-165 \$108.95



Transfer Bench

Features:

- › Textured, non-slip seat with drain holes
- › Durable 1" anodized aluminum frame will not rust
- › Reversible backrest accommodates right or left transfers
- › Ergonomically shaped back snaps in and out without tools
- › Built in soap dish and hand-held shower holders
- › Non-marring, non-slip rubber tips
- › Armrail for support while bathing and transferring in and out of the tub
- › Weight Capacity: 400 lbs.

Transfer Benches

Unassembled	226-171	\$73.73
Assembled	226-170	\$69.95
with Commode Opening	226-172	\$78.95



Sliding Transfer Benches

Features:

- › Very easy to assemble, no tools required
- › Bench slides for easy mobility
- › Height adjusts in ½" increments
- › Seat and backrest have non-slip texture finish
- › Safety belt included
- › Secured locking mechanism for both patient transfer and stationary

Transfer Benches, 400 lb. Capacity

2 in 1 Molded/Cut-Out Seat

226-836 \$151.32



Sliding Transfer Benches with Swivel Seat

Features:

- › Swivel seat enables user to turn 90° before getting in and out of the bathtub or shower
- › Double safety locks on each side of bench allows user to get on bench safely before sliding to other side and locks bench while inside the tub or shower
- › Height adjusts in ½" increments

Transfer Benches, 400 lb. Capacity

Molded Seat

226-240 \$164.47



Tub Mount Sliding Transfer Bench with Swivel Seat

Features:

- › Bathroom space saver, mounts onto the tub wall
- › Height adjustable legs
- › Dual safety lock for inside and outside position
- › Adjustable clamps
- › Weight Capacity: 350 lbs.

Transfer Benches

Molded Seat

226-244 \$210.53



Snap-n-Save Sliding Transfer Bench

Specifications:

Seat Size: 18½"x12¾"
 Seat Height: 19" to 23"
 Base Width: 37½" to 38"
 Actual Slide: 24¼"
 Clearance: 16¼" to 20¼"
 Weight Capacity:
 400 lbs.



Transfer Bench

226-232

\$142.11

XX Long Toilet to Tub Sliding Transfer Bench

Specifications:

Seat Size: 20¼"x18½"
 Seat Height: 19.5" to 24"
 Base Width: 63½" to 64"
 Clearance: 14½" to 19"
 Weight Capacity:
 250 lbs.



Extra Long Transfer Bench

226-144

\$243.42

Transfer Slider Shower/Commode Chair



Specify color from page 158

Features:

- › 24" Seat Height
- › Tub Base - 30"
- › Chair Width 22"
- › Base connected to chair 50" long
- › Four 5" locking non rust wheels



Slider Shower/Commode Chair

223-712-CL

\$908.95

Tub Slide Shower Chair

Enter the seat from either the left or the right side and also slide over the tub from either side. Enjoy the comfort of a fully padded seat and backrest. This chair rolls right over the commode, eliminating the need for a raised toilet and added grab-bars. Stainless steel construction.



Specifications:

Chair Dimensions:	26½"x21½"x41"	Floor Clearance:	19½"
Seat Dimensions:	18"x18"	Outrigger Dimensions:	29"x18"x21"
Seat Height:	23"	Outrigger HGT Adjusts:	½"
Seat Slide:	28"	Weight Capacity:	300 lbs.

Shower/Transfer Chair 226-145 \$2,255.95 DISC.

Transfer Boards



Features:

- › Transfers easily from wheelchair, bed, chair, or toilet
- › Cut out handle for easy carrying
- › Made of urethane sealed; coated and polished hardwood
- › Weight Capacity: 400 lbs.



Features:

- › Unique design for easy transfer
- › Lightweight and easy to handle
- › Made of heavy-duty white plastic
- › Weight Capacity: 500 lbs.

Transfer Boards

8"x30" wood	199-100	\$32.25
8"x27½" plastic	199-101	\$16.28
9"x24" wood, 500 lbs.	199-113	\$73.95
9"x28" wood, 700 lbs.	199-114	\$82.24



Features:

- › Made of multi-laminated birch plywood with a smooth lacquer finish
- › Ends are tapered and edges are rounded for easily sliding on and off
- › Weight Capacity: 500 lbs. and 700 lbs.

AquaJoy Reclining Bathlift

Features:

- › Heavy duty seat and base provides maximum stability and support.
- › Fits most style bathtubs.
- › Fully waterproof, floating battery hand control with easy to use convex and concave operating buttons.
- › Weight Capacity: 375 lbs.
- › Easy release suction cups on base provide maximum stability in the tub.



AquaJoy Reclining Bathlift

Reclining Bathlift

226-260

\$749.33

Bellavita Auto Bath Tub Chair Seat Lift

Features:

Completely tool-free set up makes it easy to install and operate. When not in use, back easily folds down for space-saving storage. Watertight hand control floats. The easy to use quick charge lithium-ion battery is accommodated in the hand control. Two-piece construction makes the lift easy to assemble/disassemble for transport.



Bellavita Auto Bath Tub Chair Seat Lift

Bellavita Bathlift

226-875

\$564.95

Replacement Shower Chair Backs

- Shower Chair Backs \$10.65**
- Invacare / Drive **233-300**
 - Temco 21" Wide **233-200**
 - Temco 21¾" Wide **233-202**
 - Lumex Shaped **233-100**
 - Lumex Square **233-103**



Aluminum Shower Chair

Rust resistant, ball bearing swivel casters maneuver easily.

Specifications:

- Seat Height: 21"
- Clearance: 17½"
- Between Arms: 19"
- Weight Capacity: 300 lbs.



Shower Chair 223-100 \$108.95

Mariner Rehab Chairs

Features:

- › The NEW all aluminum frame and stainless steel hardware provides optimum rust resistance
- › Ideal for use in the shower
- › Lightweight, folds easily for transport or storage
- › Standard with treaded urethane tires, new flip-up padded arms that lock down
- › Padded 4-position seat with easy access
- › Swing-away front rigging with tool-less adjustable height footrests
- › Three Year Limited Warranty
- › Weight capacity: 300 lbs.



Mariner Rehab Chair

- with 5" Casters and 18" Seat **223-524 \$595.00**
- with 23" Wheels and 16" Seat **223-523 \$595.00**
- with 23" Wheels and 18" Seat **223-522 \$595.00**

Aluminum Rehab Chair

Features:

- › Can be positioned over a standard toilet or used as a portable self contained commode
- › Floor to seat height can be adjusted 4" w/o tools
- › White aluminum frame is attractive and rust resistant for use in the shower
- › Comes with swing-away footrests with height and angle adjustable footplates
- › With 24" rear wheels
- › 24.5" Overall width open
- › Limited Lifetime Warranty
- › Weight capacity: 300 lbs.



Aluminum Rehab Shower/Commode Chair

with 24" Wheels and 24.5" Seat **223-160 \$575.00**

Aluminum Shower Commode Mobile Chair

- › Attractive; Can be positioned over a standard toilet or used as a portable self contained commode
- › Comes with swing-away footrests with height and angle adjustable footplates
- › Padded seat back and arms
- › Seat cut-out provides maximum comfort and convenience
- › White aluminum frame is attractive and rust resistant for use in the shower

Aluminum Shower Commode Mobile Chair

Mobile Chair with 5" Casters **223-304 \$549.00**



Heavy-Duty Bath Tub Chairs

Tub must be at least 22" wide and measured 1/2 way up the wall inside to inside. Bath seats are designed for tub use. NEVER use in a shower stall unless seat is nested in floor stand (available upon request).



Specifications:

Seat Height:	18½"	Overall Width:	22"
Seat Width:	20"	Overall Depth:	16½" or 23"
Seat Depth:	15¼" or 20"	Weight Capacity:	650 lbs.
Overall Height:	23½"		

15¼" Seat Depth Tub Chairs

with Toilet Seat Ring	226-800	\$127.14
with Bench Seat and Commode Opening	226-801	\$156.58
with Bench Seat and No Commode Opening	226-802	\$156.58

20" Seat Depth Tub Chair

with Bench Seat and Commode Opening	226-809	\$169.74
with Bench Seat and No Commode Opening	226-810	\$169.74

Heavy-Duty Tub Transfer Benches

Fits contour of standard bath tub. Rubber grips on tubes prevent marring tub. Short back prevents patient from falling backward and is also removable. "Posi-Lock Tee Joint" and "Tube in a Tube" for added strength. Tub must be at least 22" wide and measured ½ way up the wall inside to inside. Commode opening is 8"W x 10"L. Outside legs adjust from 18½" to 20½". Although universal, order Right or Left for bathroom configuration when possible.



Seat on Right with Commode Opening



Seat on Right without Commode Opening



Seat on Left with Commode Opening



Seat on Left without Commode Opening

Specifications:

Seat Height:	18½"	Overall Width:	44"
Seat Width:	44"	Overall Depth:	16½" or 23"
Seat Depth:	15¼" or 20"	Weight Capacity:	650 lbs.
Overall Height:	23½"		



15¼" Seat Depth Tub Transfer Bench

Seat on Left with Commode Opening	226-805	\$340.79
Seat on Left without Commode Opening	226-806	\$340.79
Seat on Right with Commode Opening	226-807	\$340.75
Seat on Right without Commode Opening	226-808	\$327.63

20" Seat Depth Tub Transfer Bench

Seat on Left with Commode Opening	226-813	\$380.26
-----------------------------------	----------------	-----------------

Heavy-Duty Shower Stool

These shower stools are made especially for shower stall use. These stools are not designed for bathtub use. The seat is made of half inch thick polyethylene, an easily cleaned material that resists molding. Constructed with "Tube in a Tube" technique for added strength. All fasteners are stainless steel to prevent rusting. Locking nuts prevent accidental loosening of nuts and bolts.

Specifications:

Seat Size:	20"x20"	Overall Height:	29½"
Seat Height:	21¼"	Weight Capacity:	850 lbs.
Back Height:	9"		



Shower Stools

with Commode Opening	226-803	\$169.47
without Commode Opening	226-804	\$169.47
with Commode Opening and Back	226-811	\$177.63
without Commode Opening and with Back	226-812	\$177.63

Heavy-Duty Shower/Commode Chairs

Constructed with 1" anodized aluminum tubing and a 7/8" inner liner for double wall tubing throughout for double strength. Anodized aluminum and stainless steel fasteners prevents rusting. Easy lock and unlock braking system on back casters. Fits over 19" commodes. Back is angled for easy pushing and pulling. Contoured arms and vinyl heel rest are standard. Available with swing-away and/or removable arms for easy transfer. Optional safety belt is available and fits any chair.

Specifications:	650 lbs.	750 lbs.
Between Arms:	26"	28"
Seat Depth:	16"	20"
Seat Height:	21"	21"
Overall Height:	35½"	35½"
Overall Width:	29"	31"
Overall Depth:	21"	25"
Commode Opening:	8"x10"	9½"x11"
Weight Capacity:	650 lbs.	750 lbs.



SHIPS BY TRUCK

750 lb. Weight Capacity
Ships by Truck



Chair with Commode Ring

Shower/Commode Chairs with Commode Ring

650 lb. Capacity	223-800	\$353.95
650 lb. Capacity with Pail	223-802	\$388.89

Shower/Commode Chair with Bench Seat

650 lb. Capacity with Commode Opening	223-801	\$413.58
750 lb. Capacity with Commode Opening	223-803	\$430.86
750 lb. Capacity with Commode Opening and Pail	223-805	\$517.28
750 lb. Capacity without Commode Opening	223-804	\$430.86
750 lb. Capacity with Commode Opening and Removable Arms	223-806	\$467.90
750 lb. Capacity with Commode Opening, Pail and Removable Arms	223-808	\$579.01
750 lb. Capacity without Commode Opening and Removable Arms	223-807	\$467.90



Chair with Bench Seat

PVC Shower/Commode Chairs

Features:

- › Deluxe elongated extra heavy-duty contoured open front seat
- › Casters and backs are double wall reinforced with schedule 40, 1" PVC
- › Aesthetically pleasing, with curved arms (no sharp edges)
- › Anti-slip safety hand grips (Arm Section)
- › Fast drying and removable mesh back
- › Personal pouch/pocket
- › All models fit over standard height toilet seats
- › Structurally designed with 30% more security (with four stainless steel bolts on commode seat)
- › All casters have threaded stem for extra security and safety, casters will not fall or pull out with normal use
- › Chairs shipped Royal Blue unless otherwise specified.

CUSTOM SIZE

Custom Sizes and configurations are available upon request. Most Chairs can be built to your specifications.



Vertical Open Front

Specify color from page 158

Specifications:

Between Arms: 15"
Seat Clearance: 16.5"
Dimensions: 19"x21.25"x38"
Weight Capacity: 300 lbs.

15" Small PVC Commode/Shower Chairs

Standard with 3" Heavy Duty Casters
3" Twin Wheel Caster Upgrade
4" Twin Wheel Caster Upgrade

223-737-CL \$95.00
243-210 No Charge
243-211 \$19.00

Specifications:

Between Arms: 18"
Seat Clearance: 17.5"
Dimensions: 22"x22.75"x38.5"
Weight Capacity: 300 lbs.

18" Standard PVC Commode/Shower Chairs

Standard with 3" Heavy Duty Casters
Folding with 3" Heavy Duty Casters (22"x23"x36")
Tilted Seat with 3" Heavy Duty Casters
Vertical Open Front with 3" Heavy Duty Casters
3" Twin Wheel Caster Upgrade
4" Twin Wheel Caster Upgrade
4" Heavy Duty Wagner Wheel Caster Upgrade
5" Heavy Duty Wagner Wheel Caster Upgrade

223-700-CL \$99.90
223-707-CL \$102.10
223-713-CL \$111.29
223-706-CL \$141.14
243-210 No Charge
243-211 \$19.00 a set
243-216 \$20.00 a set
243-217 \$30.00 a set

Specifications:

Between Arms: 21"
Seat Clearance: 18.75"
Dimensions: 25"x25.5"x38.5"
Weight Capacity: 350 lbs.



21" Wide PVC Commode/Shower Chairs

Standard with 3" Heavy-Duty Casters
4" Heavy Duty Wagner Wheel Caster Upgrade
5" Heavy Duty Wagner Wheel Caster Upgrade

223-721-CL \$142.50
243-216 \$20.00 a set
243-217 \$30.00 a set

Specifications:

Between Arms: 24"
Seat Clearance: 18.75"
Dimensions: 28"x25.5"x39.75"
Weight Capacity: 400 lbs.



24" Extra Wide PVC Commode/Shower Chairs

Standard with 4" HD Casters and 7 qt. Pail
Standard with 4" HD Casters, bar in back, 7 qt. Pail
5" Heavy Duty Wagner Wheel Caster Upgrade

223-726-CL \$147.50
223-727-CL \$157.50
243-217 \$30.00 a set

See Page 19 for Upgrades, Options, & Accessories

Upgrades and Options (must order with chair)

Safety Bar	243-203	\$19.17
Double Drop Arms	284-906-SH	\$50.67
Footrests		
Sliding Footrest	243-201	\$48.33
Standard Footrest	243-202	\$23.33
Seat Upgrades		
Open or Closed Front Soft Seat	243-205-SZ	\$79.17
Push Handles	243-209	\$13.33 a set

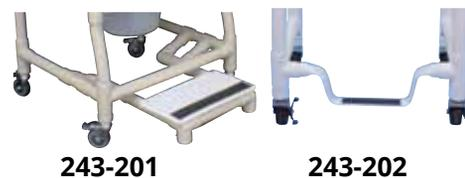

Accessories and Options

Privacy Skirts		
Specify Chair Style and Size (model # helpful)	243-200-CL	\$34.83
		Specify color from page 158
Safety Belts		
Choose Velcro or Buckle Closure	243-204-ST	\$17.42
Commode Pails		
7qt Pail	243-206-07	\$19.00
12qt Pail	243-206-12	\$20.00
Cushions		
Seat Cushion, Mesh	243-207-CL	\$38.33
Backrest Cushion, Mesh	243-208-CL	\$38.33
		Specify color from page 158



Seat Replacements		
Soft Seat, choose open or closed front	243-205-ST	\$79.17
Deluxe Closed Front Elongated Seat	243-230	\$45.03
Deluxe Closed Front Elongated Seat with Lid	243-230-WL	\$48.28
Deluxe Open Front Elongated Seat	243-234	\$51.72
Standard Seat	243-235	\$35.19

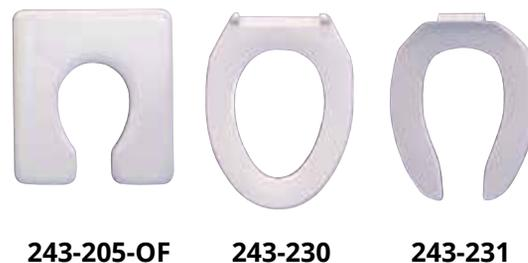

Replacement Casters		
4" Composite Twin Wheel Casters, 2 Locking 2 Non-Locking	243-240-04	\$55.69 a set
3" Wagner Casters, 2 Locking 2 Non-Locking	243-241-03	\$49.14 a set
4" Wagner Casters, 2 Locking 2 Non-Locking	243-241-04	\$58.97 a set
5" Wagner Casters, 2 Locking 2 Non-Locking	243-241-05	\$81.90 a set
3" Tente Casters, 2 Locking 2 Non-Locking	243-242-03	\$85.17 a set
5" Tente Casters, 2 Locking 2 Non-Locking	243-242-05	\$137.90 a set
5" Non-Rust Premium Casters, 2 Locking 2 Non-Locking	243-244-05	\$119.52 a set



Echo Line Shower Chair

The Echo Line Shower Chairs are made with the same quality as the standard shower chairs. They are made with less of the standard frills, to keep the cost lower.

Specifications:

Seat Width:	18" or 22"	Shipped:	UPS/RPS
Overall Width:	22" or 26"	Weight Capacity:	250 lbs.
Casters:	3" Twin Nylon		

PVC Shower Chairs

18" Wide **223-876-CL \$94.00**

Specify color from page 158



Echo Line Reclining Shower Chair

The Echo Line Reclining Shower Chairs are made with the same quality as the standard reclining shower chairs. They are made with less of the standard frills, to keep the cost lower.

Specifications:

Seat Width:	20"	Shipped:	UPS/RPS
Overall Width:	24"	Weight Capacity:	250 lbs.

PVC Reclining Shower Chair

223-878-CL \$193.52

Specify color from page 158



Reclining PVC Shower Chairs

Features:

- › Padded lumbar support and headrest
- › Deluxe elongated open front commode seat
- › Ideal for shower rooms with limited space

Specifications:

Between Arms:	21"	Overall Width:	24"
Seat Depth:	18"	Casters:	3"
Seat Height:	23.5"	Dimensions:	54.5"x24"x39.5"
Back Height:	29"	Weight Capacity:	300 lbs.

20" Wide Chair

Chair	223-733-CL \$210.00
Chair with Leg Extension	223-784-CL *\$237.12
Chair with Sliding Footrest and Leg Extension	223-739-CL \$268.75

Optional Cushions

Cushion Seat, mesh	243-207-CL \$38.33
Cushion Backrest, mesh	243-208-CL \$38.33
Privacy Skirt	243-200-CL \$34.83
5" Caster Upgrade	243-217 \$30.00

* Uses replacement pail 243-830 only

Specify color from page 158

See Page 19 for Upgrades, Options, & Accessories



Reclining Shower Chair



Chair with Sliding Footrest and Leg Extension



Chair with Padded Leg Extension

Bariatric Shower Chairs

Specifications: For 25" Chair
 Internal Width: 26"
 External Width: 30"
 Caster: 5" Casters
 Overall Size: 26"x30"x42"
 Seat Height: 22"
 Weight Capacity: 600 lbs.

25" Bariatric Chair

6 Casters, Standard Commode Seat

30" Bariatric Chair

6 Casters, Full Support Seat

See Page 19 for Upgrades, Options, & Accessories

Specify color from page 158

Specifications: For 30" Chair
 Internal Width: 30"
 External Width: 34"
 Caster: 5"x1¼" Threaded Stem
 Overall Size: 28"x34"x43"
 Seat Height: 21"
 Weight Capacity: 700 lbs.

223-729-CL \$298.20

223-766-CL \$395.00



223-766-CL

Reclineez Tilt Shower Chair

Features:

- › 6 Position Adjustable Recliner
- › Torso Safety Belt
- › Swing Away Arm on Left Side
- › 4" Twin Wheel Composite Casters
- › Fixed Angle of Seat to Back - 90°
- › Weight Capacity: 300 lbs.

Specify color from page 158

Specifications:

Internal Width: 18"
 External Width: 22"
 Seat Depth: 20"
 Upright Length: 54½"
 Reclined Length: 56½"
 Overall Height: 53"
 Seat Height: 22½"
 Back Height: 32½"

Shower Chair

18" Reclineez Tilt Chair
 Adjustable Head Stabilizer
 5" Caster Upgrade
 Privacy Skirt

223-736-CL \$325.00

243-220-CL \$36.42

243-221 \$25.00

243-200-CL \$34.83



Shower Wheelchair

Specifications:

38" High x 27.5" Wide x 30" Deep
 Seat Height: 21.5"
 Internal Width: 17.75"
 Clearance: 18.5"

Specify color from page 158

Features:

- › No rust space age PVC
- › Stainless steel front wheels
- › Anti-tip design
- › No rust all plastic rear wheels with rubber tread
- › Independent Action parking brakes
- › Swing away arm on left side

Shower Wheelchair

18", Closed Front Soft Seat

223-741-CL \$372.50





Folding Steel Commode

Features:

- › Easily opens and folds.
- › Folds flat for convenient storage and transportation.
- › Durable plastic snap on seat and lid.
- › Grey powder coated steel welded construction increases strength and durability.
- › Plastic arms for added comfort.
- › Comes complete with 7.5 qt. commode bucket, cover and splash shield.



Commode 221-118 **\$34.95**



Moen Premium Bedside Commode

Features:

- › Innovative leg design for superior stability
- › Easy Grip support handles
- › Spacious seat base provides added comfort
- › Unrestricted sides for easy access
- › Elongated opening provides more room
- › Removable waste container with handle

Specifications:

Seat Height:	16-22"
Width:	21"
Between Arms:	18½"
Leg Width:	21.625"
Leg Depth:	25"
Seat Depth:	18.5"
Weight Capacity:	400 lbs.
Commode opening:	8.5" x 12.3"

Commode 221-119 **\$110.93**



Aluminum Wheeled Commode with Plastic Armrests

Features:

- › Anodized aluminum frame
- › Back easily removes, tool free
- › Angled back for support and comfort
- › Full length plastic armrests
- › Comes with pail and cover

Specifications:

Seat Height:	21"
Between Arms:	18½"
Width:	24"
Seat Depth:	16"
Weight Capacity:	300 lbs.

Commode 223-102 **\$108.78**



4-In-One Versa Mode Commode, Raised Toilet Seat

Functions as a bedside commode; a raised toilet seat with a built-in safety frame. With bucket/splash guard removed, becomes a height-adjustable shower chair.

Specifications:

Seat Height:	18" to 22"
Width:	24.5"
Weight Limit:	250 lbs.

Commode 226-250 **\$108.57**





Folding Aluminum Commode

Features:

- › Easily opens and folds.
- › Folds flat for convenient storage.
- › Assembles without pushing buttons.
- › Durable plastic snap-on seat and lid.
- › Aluminum construction is lightweight and durable.
- › Removable tool-free back.
- › Padded arms for added comfort.



Commode **221-109 \$55.95**



Uplift Commode Assist

Uplift Commode Assist is a self powered, lifting commode chair that helps users gently lower and raise themselves.



Features:

- › Seat Height: 17" to 23"
- › Between Arms: 17¾"
- › Width: 25¾"
- › Seat Depth: 16½"
- › Weight Capacity: 300 lbs.



Uplift Commode **221-601 \$186.84**

Deluxe Steel Drop Arm Commode

Features:

- › Easy to release drop arm mechanism allows for safe lateral patient transfer to and from commode
- › Ideal for those with limited dexterity
- › Legs are adjustable
- › Easy to clean chrome plated steel finish

Specifications:

Seat Height: 19" to 23" Seat Depth: 16"
 Between Arms: 18" Weight Capacity: 300 lbs.
 Width: 23"

Commode **221-208 \$102.65**



Aluminum All-In-One Commode

Specifications:

Base Width: 25" Overall Height: 23" to 29"
 Between Arms: 19" Seat Height: 16" to 22"
 Seat Width: 16" Arm Height: 7½"
 Base Depth: 19" Weight Capacity: 300 lbs.
 Seat Depth: 14"

Commode **223-110 \$39.95**



Portable, Wheeled Drop-Arm Commode

Features:

- › 7/8" chrome plated steel tubing frame with welded construction
- › Drop arm design allows easy movement
- › Swinging and detachable footrest (sold separately)
- › Injection molded plastic toilet seat 12 quart pail and cover
- › Back can be easily removed

Commode

Chair **223-103 \$136.22**
 Footrests **140-005 \$35.95 a pair**



Specifications:

Seat Height: 20"
 Between Arms: 17"
 Width: 22"
 Weight Capacity: 350 lbs.



Shown with Optional Footrests



3 in 1 Commode with Elongated Seat Goes over standard and elongated household toilets

No need to remove back when putting over a toilet. Tuff Coat® in Gray. Toilet paper holder. Welded and steel construction. 1 1/8" tubular legs.

Specifications:	Patent Pending
Seat Height: 18 1/2" to 22 1/2"	Seat Depth: 19 3/4"
Between Arms: 17 3/4"	Weight Capacity: 400 lbs.
Width: 21"	

Commode 221-111 **\$129.77**



Heavy-Duty Commode

- Features:**
- › Designed for bedside use
 - › Rectangular pan and pan holder
 - › Armrests for added comfort



Heavy Duty Commode
450 lb. Weight Capacity 221-822 **\$79.95 DISC.**



Folding All-In-One Bariatric Commode

- Features:**
- › Accommodates individuals up to 650 lbs. (Deeper seat depth)
 - › Back is easy to install or remove with wing nuts
 - › Comes complete with no-chip, composite seat, lid, splash shield, 12 qt. bucket and cover
 - › Welded, grey powder coated heavy duty steel tubing
 - › Plastic armrests provide comfort and stability

Commode 221-821 **\$87.12**



Oversized Commode

- Features:**
- › Large padded backrest provides patient comfort
 - › Durable 1" steel tubing is sturdy and easy to maintain
 - › Large durable Snap-on seat
 - › Comes with commode bucket, cover and splash shield
 - › Weight Capacity: 650 lbs.

Commode 221-802 **\$129.95**



Oversized Drop-Arm Commode



Features:

- › Drop arm for easy transfer
- › Durable 1" steel tubing is sturdy and easy to maintain
- › Large durable Snap-on seat
- › Comes with seat, lid, bucket and cover
- › Weight Capacity: 650 lbs.



Commode **221-803 \$181.76**

Extra-Large, Heavy-Duty, Drop Arm Commodes



Features:

- › Extra large opening in toilet seat, 8½"x12"
- › Blow-molded extra wide and deep toilet seat
- › All steel construction
- › Easy-to-release drop arm mechanism allows for safe lateral transfer to and from commode
- › Plastic armrests provide comfort and support
- › Comes complete with commode bucket and cover



Commode
 1,000 lb. Weight Capacity **221-804 \$316.08**
 Commode Bucket **221-806 \$21.67**

Heavy-Duty Commodes

Features:

- › Constructed of anodized aluminum tubing
- › Extra deep bucket to prevent splashing
- › "Tube in Tube" construction for added strength
- › User friendly arm allow for easy transfers

Specifications:

Seat Height: 21"
 Seat Depth: 17¾"
 Between Arms: 24"
 Weight Capacity: 850 lbs.

Commodes

No Arms	221-813	\$353.95
No Left Arm	221-811	\$353.95
No Right Arm	221-812	\$353.95
Extra Tall, 24" Seat Height	221-814	\$353.95
Removable Left Arm	221-815	\$381.58
Removable Right Arm	221-816	\$381.58
Removable Both Arms	221-817	\$401.23



Transport Shower Gurney



Specifications:

Length: 77"
 Width: 33"
 Height: 35"
 Weight Capacity: 450 lbs.



Gurney **223-748-CL \$264.75**

Specify color from page 158

Standard Sling Gurney



Specifications:

Length: 79"
 Width: 28"
 Height: 33½" rails down, 43" rails up
 Weight Capacity: 350 lbs.



With Drain Pan and Drain Hose **223-791-CL \$391.59**

Pediatric Sling Gurney



Specifications:

Length: 60"
 Width: 28"
 Height: 33½" rails down, 43" rails up
 Weight Capacity: 300 lbs.



Without Drain Pan or Drain Hose **223-815-CL \$319.05**

Adjustable Back Shower Gurney



Specifications:

Length: 77"
 Width: 33"
 Height: 35"
 Weight Capacity: 450 lbs.



W/ Drain Pan and Drain Hose & Pad **223-747-ST \$538.33**

Bariatric Adjustable Back Shower Gurney



Specifications:

Length: 77"
 Width: 35"
 Height: 35"
 Weight Capacity: 600 Lbs.



With Drain Pan & Pad **223-747-HD \$697.84**

Multi-Position Sling Gurney



Specifications:

Length: 79"
 Width: 31"
 Height: 30" rails down, 38" rails up
 Weight Capacity: 350 lbs.



Gurney **223-816-CL \$363.86**

Specify color from page 158

No-Slip Strip By 3M

No-Slip-Strip with heavy-duty adhesive. Use in bathrooms, hallways, ramps, rails, footplates, stairs, showers or anywhere you need no-slip protection. Rolls are 60 feet long.

Anti-Slip Tape

- Black, 1" **229-005** **\$40.90 per roll**
- Black, 2" **229-006** **\$97.65 per roll**



Safe-Solution® Anti-Slip Treatment for Tile Floors and Steel-Enameled Bathtubs

What is Safe Solution?

The Safe Solution is an exclusive, proprietary product providing unsurpassed anti-slip qualities. It is biodegradable and environmentally safe. It's a three component chemical solution treatment designed to increase traction by creating microscopic channels in most hard mineral surfaces; such as: ceramic tile, clinker/quarry tile, porcelain tiles, granite, and steel-enamel bathtubs.

The Safe Solution:

Is a treatment, not a paint or coating, that is applied to non-porous hard mineral surfaces. Prior to the application of the Safe Solution, when water or grease puddle on these surfaces, you were actually hydroplaning on the film of water or contaminants. After the Safe Solution Anti-Slip Treatment System is applied, a microscopic channel is created for the water and oils to be disbursed from under foot, allowing you to make better contact with the surface at all times. "The Safe Solution dramatically increases traction by increasing the coefficient of friction."

The Maintenance Solution™:

Is an antibacterial, nontoxic, high performance, multipurpose cleaner. It's formulated to be used from the toughest commercial applications to cleaning windows. Its dilution capabilities make it a cost efficient and effective daily cleaning regimen for a myriad of industrial, commercial, and residential uses. Recommended for cleaning floors and tubs treated with "Safe Solution".



It is truly Amazing!

**We have testimonials from:
 Best Western, Domino's Pizza,
 DoubleTree Hotels, Holiday
 Inn, Howard Johnson, Ramada,
 Super 8 and more.**

Safe Solution

- 1 Tub or 17 Square Feet **400-250** **\$29.95**
- 2 Tubs or 35 Square Feet **400-251** **\$40.75**
- 24 Tubs or 420 Square Feet **400-252** **\$315.32**

Maintenance Solution

- 4, 1 Gallon Bottles **400-254** **\$85.60**
- 5 Gallon Container **400-253** **\$99.94**

For larger quantities, please call for special pricing! Full application and maintenance programs are available where we take care of everything.

Shower/Bath Mat

Rubber suction cups attach securely to shower/tub floors creating a skid resistant surface and safe bathing environment.

Size: 16" x 41"



Shower/Bath Mat 224-216 \$15.80



No Rinse Hand Sanitizer

Features:

- › Safe, Effective, Alcohol Free
- › Antibacterial foaming formula with aloe vera
- › Approximately 118 Applications per 47 ml bottle

6 One Liter Containers / Case 317-136 \$75.17



EZ-Shower

Features:

- › Nylon cord for hanging shower
- › Hangs on bed post or I.V. pole
- › Holds 2½ gallons of water
- › Flexible 2 foot hose with on/off switch
- › Latex free

Shown with EZ-Shampoo EZ-Shower 229-100 \$20.92



EZ-Shampoo

Features:

- › Made of heavy-duty vinyl
- › Inflates to 24"x20"x8"
- › Inflatable headrest for added comfort
- › Drain hose and stopper
- › Latex free



EZ-Shampoo 229-101 \$34.92



EZ-Bathe

Features:

- › Fits all beds
- › Inflatable pillow
- › 25 foot reinforced drain hose with on/off switch
- › 25 foot hose with shower head
- › Wet and dry vacuum
- › 71"x31"x13½"
- › Latex free

EZ-Bathe Tub with Accessories 229-102 \$338.42
Tub 229-104 \$185.00



EZ-Shampoo Hair Washing Tray

Easy to use plastic tray rests comfortably on patients shoulders for easy upright shampooing. Features unique flexible rubber facing which surrounds tray and neck opening to provide superior comfort and prevent slipping. 35" strap wraps around client's forearm to stabilize tray. Can be used with almost any chair. Latex free.

EZ-Shampoo Tray 229-103 \$26.17

No-Rinse For bathing when using a tub is inconvenient or impossible.

No-Rinse Bathing Wipes

- › One complete bath (8 wipes)
- › Cleans and Deodorizes
- › Can be warmed in microwave

No-Rinse Body Bath

- › Concentrated formula
- › 1 oz. in basin for basin bath
- › No rinsing is required

No-Rinse Shampoo

- › Ready to use, no water needed
- › Eliminates odors

No-Rinse Hair Conditioner

- › Ready to use
- › Apply and leave in or towel dry
- › May be rinsed if desired
- › Detangles, adds extra body



No-Rinse Wipes

Case of 24-8 Packs **317-126 \$61.20 a case**

No-Rinse Body Bath

Case of 12-2 oz. Bottles **317-127 \$12.40 a case**
Case of 144-2 oz. Bottles **317-128 \$104.91 a case**
Case of 24-8 oz. Bottles **317-129 \$68.40 a case**
Case of 12-16 oz. Bottles **317-130 \$57.20 a case**
Case of 4-1 Gallon Bottles **317-131 \$92.80 a case**

No-Rinse Shampoo

Case of 12-2 oz. Bottles **317-120 \$12.00 a case**
Case of 144-2 oz. Bottles **317-121 \$100.80 a case**
Case of 24-8 oz. Bottles **317-123 \$60.40 a case**
Case of 12-16 oz. Bottles **317-124 \$53.80 a case**
Case of 4-1 Gallon Bottles **317-125 \$76.87 a case**

No-Rinse Conditioner

Case of 144-2 oz. Bottles **317-132 \$104.91 a case**
Case of 12-8 oz. Bottles **317-133 \$24.40 a case**

Hand-Held Shower Sprayer

Features:

- › Wall holder and extra long 80" white reinforced nylon hose provides extra convenience
- › Comes with diverter valve that allows for use with either traditional shower head or shower spray

Shower Sprayer **224-221 \$16.82**



HealthSmart LumaTemp LED Shower Sprayer

Features:

- › Visual temperature of the water prevents relying on touch
- › Hydro-powered LED color indicator automatically illuminates the water to blue, green or red based on the temperature
- › No electricity or batteries required
- › Easy Installation
- › Includes removable 5-foot flexible hose and fits most standard shower connectors (3/4")

LED Shower Sprayer **224-227 \$35.95**



Flow Control Hand-Held Shower

Features:

- › ADA compliant
- › Reduce water flow with the exclusive flow control button
- › Lightweight, soft grip handle with safety strap provides a secure grip
- › Extra-long 7 foot flex soft hose

Shower Sprayer **224-206 \$35.95**



Sure Chek Shower Curtains

Sure-Chek Shower Curtains are flame resistant, stain resistant, antistatic, odor resistant, durable, antimicrobial, durable, decorative, economical shower curtains. Sure-Chek Shower Curtains are the national best-seller for Healthcare facilities is heavy weight (coated) IFR polyester with patented inert chemicals to provide anti-bacterial, anti-microbial and anti-static properties for the life of the product. Sure Chek curtains are made with durable #2 grommets and to help ensure against the buildup of bacteria are manufactured with no side or bottom hems.

Horizontal Width

Vertical Height	054"	Part Number	072"	Part Number
	72"	\$41.60	218-445-CL	\$46.80
75"	\$42.40	218-446-CL	\$46.80	218-453-CL
78"	\$42.40	218-447-CL	\$47.00	218-458-CL
081"	\$43.20	218-448-CL	\$47.60	218-454-CL
084"	\$43.20	218-449-CL	\$47.60	218-455-CL
087"	\$44.40	218-450-CL	\$47.60	218-456-CL
090"	\$45.60	218-451-CL	\$48.00	218-457-CL



Sure Chek Shower Curtain Colors:



03 Fawn

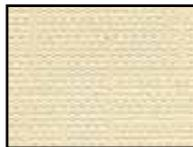

02 Dune

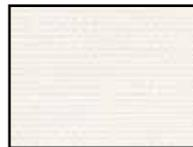

01 White

More colors and sizes available at www.ocelco.com

(S4) Chalet Shower Curtains

Chalet shower curtains are treated with an anti-microbial agent that inhibits and controls bacteria and mildew growth. Visa ® fabric is breathable and resists stains, Woven: 100% polyester with Visa ® finish

Horizontal Width

Vertical Height	36"	42"	48"	54"	60"	70"	78"	84"	90"	102"
	72"	\$78.00	\$78.00	\$78.00	\$78.00	\$78.00	\$78.00	\$120.75	\$120.75	\$121.75
78"	\$78.00	\$78.00	\$78.00	\$78.00	\$78.00	\$78.00	\$120.75	\$120.75	\$121.75	\$121.75
84"	\$78.00	\$78.00	\$78.00	\$78.00	\$78.00	\$78.00	\$78.00	\$78.00	\$137.30	\$137.30
90"	\$78.00	\$78.00	\$78.00	\$78.00	\$78.00	\$78.00	\$78.00	\$78.00	\$137.30	\$137.30

Wholesale (catalog) Curtains Part Number and Pricing Guide

Build Your Own Part Number	Category	-	Width	Height	Pattern	Color
Sample	S4	-	072	084	A	01

S4-072084A01

(A) pattern: Chalet Colors:

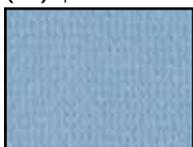

01 Blue Moon



02 Cafe



03 Cream



04 Doeskin



05 Palm



06 Snow

Steel Transport Chair

Specifications:

Overall Width 17" Chair: 18" Back Height: 18"
 Overall Width 19" Chair: 20" Seat Width: 17" and 19"
 Width Folded: 8" Seat Depth: 16"
 Overall Height: 39" Length w/Rigging: 33"
 Floor to Seat Height: 19" Weight Capacity: 300 lbs.
 Silver Vein frame finish

Fixed Full Arms

17" Wide
 19" Wide

\$88.00
010-334
010-336



Lightweight Aluminum Transport Chair

Weighs only 19 lbs. Standard swing-away footrests with die-cast aluminum footplates. Comes with seat belt for added safety. Upholstery comes in black, choose frame color of black, blue or red.

Specifications:

Overall Width 17" Chair: 20" Back Height: 18"
 Overall Width 19" Chair: 22" Seat Width: 17" or 19"
 Width Folded: 9" Seat Depth: 16"
 Overall Height: 39.5" Length w/Rigging: 33"
 Floor to Seat Height: 19" Weight Capacity: 300 lbs.

Aluminum Transport Chair

17" Wide
 19" Wide

\$119.95
010-320-CL
010-321-CL
\$14.95
275-160



Deluxe Transport Chair

Features:

- › 8" casters in front and rear
- › Aluminum frame for lightweight strength and durability
- › Back folds down for easy storage and transport and features deluxe back release
- › Both 17" and 19" come with tool free, swing-away footrests
- › Comes with carry pocket on back of seat
- › Comes with seat belt for added safety
- › Deluxe all aluminum rear wheel locks
- › Soft plush upholstery
- › Weighs only 19lbs
- › Choose from Tan Plaid or Burgundy

19" Wide Transport Chair 010-344-CL \$149.00



Heavy-Duty

Features:

- › Supports individuals up to 450 lbs.
- › Reinforced steel frame provides added support
- › Heavy-Duty, reinforced upholstery with a back carry pouch
- › Removable, reversible desk length arms
- › Adjustable leg support
- › Dual, reinforced steel cross braces
- › 12" flat free rear wheels
- › Available in Red, Blue or Chrome

20" Wide Transport Chairs 010-326-CL \$196.04
22" Wide Transport Chairs 010-329-CL \$209.20





Silver Sport 2

Features:

- › Powder coated silver vein steel frame
- › Padded armrest
- › Embossed vinyl upholstery is durable, lightweight, attractive and easy to clean
- › Urethane tires mount on composite wheel provides durability and low maintenance
- › Push to lock brakes
- › Carry pocket on backrest provides additional convenience
- › Weight capacity: 250 lbs.

16" Wide Wheelchairs

Fixed Arms with Footrests	010-122-F	\$133.00
Fixed Arms with Legrests	010-122-L	\$143.37
Detachable Desk Arms with Footrests	010-123-F	\$131.00
Detachable Desk Arms with Legrests	010-123-L	\$152.00

18" Wide Wheelchairs

Fixed Arms with Footrests	010-125-F	\$134.05
Fixed Arms with Legrests	010-125-L	\$143.37
Detachable Desk Arms with Footrests	010-124-F	\$131.00
Detachable Desk Arms with Legrests	010-124-L	\$141.00

20" Wide Wheelchairs

Detachable Desk Arms with Footrests	010-128-F	\$136.00
Detachable Desk Arms with Legrests	010-128-L	\$144.00



Invacare Veranda

The Invacare Veranda Standard Wheelchair provides comfort and mobility in an economical package. The 18" seat width comes standard with one-piece padded non-removable armrests and the 16" and 20" seat widths have removable desk length armrests standard. The Veranda comes with a stylish silver vein finish, padded nylon upholstery and has the option for removable desk-length arms for the 18" seat and padded elevating legrests for all seat widths.

Features:

- › Padded nylon upholstery
- › Comfortable padded arms
- › Back-mounted carrying pouch
- › Overall Width - Folded: 14.00"
- › Quick-Release Axles: No
- › Weight Capacity: 250 Lbs.
- › Weight: 37 Lbs.



Cruiser III

Features:

- › Flip back removable arms allow for easy transfer
- › Carbon steel frame with silver vein finish
- › Comes with push to lock wheel locks
- › Weighs under 36 lbs. (excluding front riggings)

Specifications:

Width (closed):	12"
Height:	35"
Seat Depth:	16"
Back Height:	16"
Weight:	36 lbs. (without front riggings)
Weight Capacity:	16" and 18" - 300 lbs., 20" - 350lbs



16" Wide Wheelchairs, Flip Back Arms

Detachable Desk Arms with Footrests	010-107-F	\$152.00
Detachable Desk Arms with Legrests	010-107-L	\$165.00
Detachable Full Arms with Footrests	010-113-F	\$152.00
Detachable Full Arms with Legrests	010-113-L	\$165.00

18" Wide Wheelchairs, Flip Back Arms

Detachable Desk Arms with Footrests	010-109-F	\$152.00
Detachable Desk Arms with Legrests	010-109-L	\$165.00
Detachable Full Arms with Footrests	010-114-F	\$152.00
Detachable Full Arms with Legrests	010-114-L	\$165.00

20" Wide Wheelchairs, Flip Back Arms

Detachable Desk Arms with Footrests	010-111-F	\$152.00
Detachable Desk Arms with Legrests	010-111-L	\$165.00
Detachable Full Arms with Footrests	010-115-F	\$152.00
Detachable Full Arms with Legrests	010-115-L	\$165.00

Tracer EX2

Features:

- › Quick adjust knobs for simple footplate adjustment
- › 14-gauge crossbraces add strength and durability
- › Dual axle positions allow variation of seat heights
- › Durable, low maintenance, triple chrome-plated, carbon steel frame is long-lasting
- › Offset permanent arms available in 16", 18" and 20" widths
- › Urethane rear tires, mounted on "no flex" wheels, offer superior performance
- › Lifetime Warranty on frame and crossbraces



16" Wide Wheelchairs with Detachable Front Riggings

Detachable Desk Arms and Footrests	010-182-F	\$165.40
Detachable Desk Arms and Legrests	010-182-L	\$175.30
Detachable Full Arms and Footrests	010-183-F	\$165.40
Detachable Full Arms and Legrests	010-183-L	\$175.30

18" Wide Wheelchairs with Detachable Front Riggings

Fixed Full Arms and Footrests	010-175-F	\$165.40
Fixed Full Arms and Legrests	010-175-L	\$175.30
Detachable Desk Arms and Footrests	010-177-F	\$165.40
Detachable Desk Arms and Legrests	010-177-L	\$175.30
Detachable Full Arms and Footrests	010-179-F	\$165.21
Detachable Full Arms and Legrests	010-179-L	\$175.11

20" Wide Wheelchairs with Detachable Front Riggings

Fixed Full Arms and Footrests	010-254-F	\$168.70
Fixed Full Arms and Legrests	010-254-L	\$175.60
Detachable Desk Arms and Footrests	010-185-F	\$166.50
Detachable Desk Arms and Legrests	010-185-L	\$176.40
Detachable Full Arms and Footrests	010-186-F	\$165.70
Detachable Full Arms and Legrests	010-186-L	\$175.60

Specifications:

Seat Height:	Standard 17½" and 19½"
Back Height:	16"
Weight:	36 lbs. (without front riggings)
Weight Capacity:	250 lbs.
Front Riggings:	
	Hemi Swing-away Footrests 17" to 21"
	Hemi Swing-away Elevating Legrests 17½" to 21"



Tracer SX5

Features:

- › Quick adjust knobs for simple footplate height adjustment
- › Dual axle positions allow variation of seat to floor heights
- › Durable, low maintenance, triple chrome plated, carbon steel frame is long-lasting
- › 14-gauge crossbraces add strength and durability
- › Sectional back with removable back canes
- › Urethane rear tires, mounted on "no flex" wheels, offers superior performance
- › Interchangeable components with the 9000 Series
- › The 20" and 22" widths include a semi-pneumatic caster and chrome hand rim to accommodate additional weight
- › Lifetime Warranty on frame and crossbraces

Specifications:

Seat Height:	Standard 17½" and 19½" Super Hemi 15½" and 17½"
Back Height:	16" (with removable back canes)
Weight:	34 lbs. (without front riggings)
Weight Capacity:	250 lbs. 300 lbs. on 20" and 22" Wide
Front Riggings:	
Hemi Swing-away Footrests	17" to 21"
Hemi Swing-away Elevating Legrests	17½" to 21"

14" Wide Wheelchairs with Flip Back Arms and Swing-away Detachable Front Riggings

14"x16" with Desk Arms and Footrests	010-217-F	\$229.00
14"x16" with Desk Arms and Legrests	010-217-L	\$249.00
14"x16" with Full Arms and Footrests	010-219-F	\$229.00
14"x16" with Full Arms and Legrests	010-219-L	\$249.00

16" Wide Wheelchairs with Flip Back Arms and Swing-away Detachable Front Riggings

16"x16" with Desk Arms and Footrests	010-133-F	\$211.68
16"x16" with Desk Arms and Legrests	010-133-L	\$221.58
16"x18" with Desk Arms and Footrests	010-161-F	\$265.00
16"x18" with Desk Arms and Legrests	010-161-L	\$275.00
16"x16" with Full Arms and Footrests	010-132-F	\$215.00
16"x16" with Full Arms and Legrests	010-132-L	\$275.00
16"x18" with Full Arms and Footrests	010-160-F	\$265.00
16"x18" with Full Arms and Legrests	010-160-L	\$275.00

18" Wide Wheelchairs with Flip Back Arms and Swing-away Detachable Front Riggings

18"x16" with Desk Arms and Footrests	010-130-F	\$200.50
18"x16" with Desk Arms and Legrests	010-130-L	\$210.40
18"x18" with Desk Arms and Footrests	010-159-F	\$265.00
18"x18" with Desk Arms and Legrests	010-159-L	\$275.00
18"x16" with Full Arms and Footrests	010-129-F	\$198.29
18"x16" with Full Arms and Legrests	010-129-L	\$208.19
18"x18" with Full Arms and Footrests	010-158-F	\$265.00
18"x18" with Full Arms and Legrests	010-158-L	\$275.00

20" Wide Wheelchairs with Flip Back Arms and Swing-away Detachable Front Riggings

20"x18" with Desk Arms and Footrests	010-157-F	\$279.00
20"x18" with Desk Arms and Legrests	010-157-L	\$289.72
20"x16" with Full Arms and Footrests	010-126-F	\$214.92
20"x16" with Full Arms and Legrests	010-126-L	\$225.00
20"x18" with Full Arms and Footrests	010-156-F	\$279.00
20"x18" with Full Arms and Legrests	010-156-L	\$289.00

22" Wide Wheelchairs with Flip Back Arms and Swing-away Detachable Front Riggings

22"x16" with Desk Arms and Footrests	010-119-F	\$221.40
22"x16" with Desk Arms and Legrests	010-119-L	\$231.30
22"x18" with Desk Arms and Footrests	010-121-F	\$269.00
22"x18" with Desk Arms and Legrests	010-121-L	\$279.00
22"x16" with Full Arms and Footrests	010-118-F	\$364.00
22"x16" with Full Arms and Legrests	010-118-L	\$327.95
22"x18" with Full Arms and Footrests	010-120-F	\$271.00
22"x18" with Full Arms and Legrests	010-120-L	\$338.29

-S Super Hemi 15 1/2" Seat to Floor Height

Add **-S** after any SX5 Series item number for a Super Hemi setup. There is an up charge of **\$49.95**. 20" and 22" wide wheelchairs may not be made into Super Hemi.

Traveler

Features:

- › Double padded Dark Blue upholstery and padded armrests
- › Dual rear axle positioning for seat heights from 17¾" to 19¾" and seat widths from 16" to 20" wide
- › Reversible detachable arms for added versatility
- › Weight Capacity: 300 lbs.

16" Wide Wheelchairs (Standard height is 19¾")

Detachable Desk Arms with Footrests	010-204-F	\$230.26
Detachable Desk Arms with Legrests	010-204-L	\$236.84

18" Wide Wheelchairs

Detachable Desk Arms with Legrests	010-202-L	\$164.47
------------------------------------	------------------	-----------------



Traveler SE

Features:

- › Black vinyl upholstery
- › Chart pocket on back
- › "Tool Free" adjustable front rigging
- › Hammer tone paint provides a long lasting and durable finish
- › Industry compatible front rigging
- › Two position axle and caster fork provides 2" seat height adj.
- › 250 lb. weight capacity
- › Meets Medicare code K0001 and K0002

16" Wide Wheelchairs

Detachable Desk Arms with Footrests	010-142-F	\$151.32
Detachable Desk Arms with Legrests	010-142-L	\$164.47
Detachable Full Arms with Footrests	010-143-F	\$151.32
Detachable Full Arms with Legrests	010-143-L	\$164.47

18" Wide Wheelchairs

Fixed Full Arms with Footrests	010-138-F	\$144.74
Fixed Full Arms with Legrests	010-138-L	\$157.89
Detachable Desk Arms with Footrests	010-139-F	\$151.32
Detachable Desk Arms with Legrests	010-139-L	\$164.47
Detachable Full Arms with Footrests	010-140-F	\$151.32
Detachable Full Arms with Legrests	010-140-L	\$164.47

20" Wide Wheelchairs

Detachable Full Arms with Footrests	010-145-F	\$157.89
Detachable Full Arms with Legrests	010-145-L	\$171.05
Detachable Desk Arms with Footrests	010-144-F	\$157.89
Detachable Desk Arms with Legrests	010-144-L	\$171.05





Traveler Heavy Duty

Features:

- › Embossed black leatherette upholstery with double inner lining for durability
- › 18" seat depth (1" longer than standard)
- › Hammer tone paint provides a long lasting and durable finish
- › Reinforced frame at all critical load-bearing points
- › Two position axle and caster fork provides 2" seat height adjustment
- › Durable aluminum black footplates
- › User friendly swing-away detachable footrests or elevating legrests
- › Weight Capacity: 500 lbs.

20" Wide Wheelchairs with Detachable Arms

Desk Arms with Swing-away Footrests	010-270-F	\$250.00
Desk Arms with Elevating Legrests	010-270-L	\$263.16
Full Arms with Swing-away Footrests	010-271-F	\$250.00
Full Arms with Elevating Legrests	010-271-L	\$263.16

22" Wide Wheelchairs with Detachable Arms

Desk Arms with Swing-away Footrests	010-272-F	\$256.58
Desk Arms with Elevating Legrests	010-272-L	\$269.74
Full Arms with Swing-away Footrests	010-273-F	\$256.58
Full Arms with Elevating Legrests	010-273-L	\$264.74

24" Wide Wheelchairs with Detachable Arms

Desk Arms with Swing-away Footrests	010-274-F	\$263.16
Desk Arms with Elevating Legrests	010-274-L	\$276.32
Full Arms with Swing-away Footrests	010-275-F	\$263.16
Full Arms with Elevating Legrests	010-275-L	\$276.32

Tracer IV

Features:

- › Durable, low maintenance, triple chrome plated, carbon steel frame is long lasting
- › Reinforced frame includes gusseted sides, caster journals and dual crossbraces
- › Heavy-duty inner liners keep seat and back from stretching
- › Weight Capacity: 350 lbs.
- › Heavy-duty package to increase weight capacity to 450 lbs. is available



20" Wide Wheelchairs

Detachable Full Arms with Footrests	010-150-F	\$327.11
Detachable Full Arms with Legrests	010-150-L	\$340.13
Detachable Desk Arms with Footrests	010-151-F	\$327.11
Detachable Desk Arms with Legrests	010-151-L	\$340.13

22" Wide Wheelchairs

Detachable Full Arms with Footrests	010-152-F	\$327.11
Detachable Full Arms with Legrests	010-152-L	\$340.13
Detachable Desk Arms with Footrests	010-153-F	\$327.11
Detachable Desk Arms with Legrests	010-153-L	\$340.13

24" Wide Wheelchairs

Detachable Full Arms with Footrests	010-154-F	\$327.11
Detachable Full Arms with Legrests	010-154-L	\$340.13
Detachable Desk Arms with Footrests	010-155-F	\$327.11
Detachable Desk Arms with Legrests	010-155-L	\$340.13

Sentra EC Heavy Duty



Features:

- › Dual cross brace
- › Carbon steel frame with triple chrome plated for an attractive, chip-proof, maintainable finish
- › Double embossed vinyl upholstery is durable, lightweight, attractive and easy to clean
- › Urethane tires mounted on composite wheels provide maximum durability and low maintenance
- › Aluminum footplates
- › Comes with padded armrests
- › Maintenance free, sealed precision bearings
- › Plastic hand rims standard
- › Color: Black Upholstery
- › Weight capacity: 450 lbs.

20" Wide Wheelchairs

- Detachable Desk Arms with Footrests **010-809-F \$230.26**
- Detachable Desk Arms with Legrests **010-809-L \$243.42**
- Detachable Full Arms with Footrests **010-816-F \$230.26**
- Detachable Full Arms with Legrests **010-816-L \$243.42**

22" Wide Wheelchairs

- Detachable Desk Arms with Footrests **010-817-F \$230.26**
- Detachable Desk Arms with Legrests **010-817-L \$243.42**
- Detachable Full Arms with Footrests **010-818-F \$277.93**
- Detachable Full Arms with Legrests **010-818-L \$243.42**

24" Wide Wheelchairs

- Detachable Desk Arms with Footrests **010-819-F \$263.16**
- Detachable Desk Arms with Legrests **010-819-L \$276.32**
- Detachable Full Arms with Footrests **010-820-F \$263.16**
- Detachable Full Arms with Legrests **010-820-L \$276.32**

Sentra Heavy-Duty, Extra Wide

Features:

- › Reinforced steel gussets provide additional strength
- › Extra large, plastic armrests provide comfort and support
- › Dual axle provides easy transition of seat to hemi level
- › Black nylon upholstery
- › Powder coated silver vein frame



Specifications:

- Overall Width: 34½" 26" Wide
- 37" 28" Wide
- 39" 30" Wide
- Overall Length: 43"
- Floor to Seat Height: 17½" to 19½"
- Back Height: 18"
- Seat Depth: 18"
- Weight Capacity: 700 lbs.

30" Wide Wheelchairs

- Detachable Desk Arms with Footrests **010-814-F \$941.98**
- Detachable Desk Arms with Legrests **010-814-L \$976.53**

26" Wide Wheelchairs

- Detachable Full Arms with Footrests **010-811-F \$528.40**
- Detachable Full Arms with Legrests **010-811-L \$542.73**



drive
for the road ahead



\$279.00

Silver Sport Full Reclining

Features:

- › Reclining mechanism allows for infinite adjustments up to 180°
- › Carbon Steel frame with silver vein finish
- › Durable, lightweight nylon upholstery, Padded Armrest
- › Wheels set back on frame prevents tipping
- › Headrest extension with cushioned head immobilizer
- › Weight Capacity: 300 lbs.

Recliners with Legrests

16" Wide with Detachable Desk Arms	\$288.16	010-718-L
18" Wide with Detachable Desk Arms		010-719-L
20" Wide with Detachable Desk Arms		010-720-L



Everest & Jennings®

Traveler

Features:

- › Double padded Deep Blue upholstery and padded armrests
- › Reversible detachable arms for added versatility
- › Chrome steel frame
- › Reinforced top inner rail for extra strength
- › Weight Capacity: 250 lbs.

16" Wide Recliners with Legrests

Detachable Full Arms	010-233-L	\$395.06
Detachable Desk Arms	010-234-L	\$401.23

18" Wide Recliners with Legrests

Detachable Full Arms	010-231-L	\$401.23
Detachable Desk Arms	010-232-L	\$395.06

20" Wide Recliners with Legrests

Detachable Full Arms	010-235-L	\$407.41
Detachable Desk Arms	010-236-L	\$401.23



INVACARE



Tracer SX5 Recliner

Features:

- › Heavy-duty inner liners keep seat and back from stretching
- › Triple chrome plated, carbon steel frame is long lasting
- › Offers dynamic recline range from 100° to 168°
- › Weight Capacity: 250 lbs. (300 lbs. 20" and 22" width)

20" Wide Wheelchair with Swing-away Detachable Legrests

20"x16" with Detachable Desk Arms	010-404-L	\$403.37
20"x16" with Detachable Full Arms	010-405-L	\$403.37
20"x18" with Detachable Desk Arms	010-238-L	\$470.51
20"x18" with Detachable Full Arms	010-239-L	\$470.51

16" Wide Wheelchair with Swing-away Detachable Legrests

16"x16" with Detachable Desk Arms	010-400-L	\$394.60
16"x16" with Detachable Full Arms	010-401-L	\$409.30
16"x18" with Detachable Desk Arms	010-223-L	\$474.11
16"x18" with Detachable Full Arms	010-224-L	\$474.11

22" Wide Wheelchair with Swing-away Detachable Legrests

22"x16" with Detachable Desk Arms	010-406-L	\$455.00
22"x16" with Detachable Full Arms	010-407-L	\$455.00
22"x18" with Detachable Desk Arms	010-244-L	\$470.51
22"x18" with Detachable Full Arms	010-245-L	\$470.51

18" Wide Wheelchair with Swing-away Detachable Legrests

18"x16" with Detachable Desk Arms	010-402-L	\$394.60
18"x16" with Detachable Full Arms	010-403-L	\$409.30
18"x18" with Detachable Desk Arms	010-225-L	\$474.11
18"x18" with Detachable Full Arms	010-237-L	\$424.11

Standard Rear Anti-Tippers

These anti-tippers fit standard frames for E&J, Theradyne, Tuffcare, Hoyer, Old Style Invacare, and others with a kick tube height of 3" to 5" from bottom of kick tube to floor. Fit on the outside of tubing.

Push Button Anti-Tipper

\$33.00 a pair

- A. Wheeled, fits over 7/8" O.D. Tubing
- A. Wheeled, fits over 1" O.D. Tubing
- B. Bumper, fits over 7/8" O.D. Tubing
- B. Bumper, fits over 1" O.D. Tubing

193-124

193-122

193-120

193-121

Clamp On Anti-Tipper

\$37.00 a pair

- C. Wheeled, fits over 7/8" O.D. Tubing
- C. Wheeled, fits over 1" O.D. Tubing
- D. Bumper, fits over 7/8" O.D. Tubing
- D. Bumper, fits over 1" O.D. Tubing

193-110

193-113

193-111

193-112

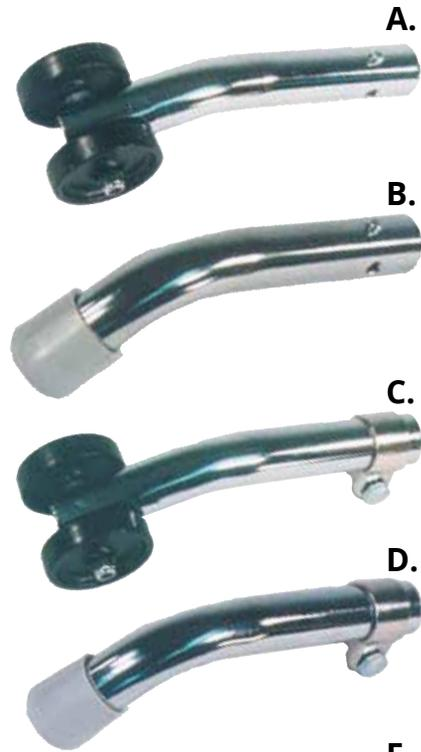

Adjustable Height Rear Anti-Tippers

These anti-tippers fit standard frames for new style Invacare, Medline and others with a kick tube height of 6" to 10½" from bottom of kick tube to floor. Fit on the outside of tubing.

Push Button Anti-Tipper

\$45.00 a pair

- E. Wheeled, fits over 7/8" O.D. Tubing
- E. Wheeled, fits over 1" O.D. Tubing
- F. Bumper, fits over 7/8" O.D. Tubing
- F. Bumper, fits over 1" O.D. Tubing

193-140

193-141

193-142

193-143

Clamp On Anti-Tipper

\$49.00 a pair

- G. Wheeled with bumper, fits over 7/8" O.D. Tubing
- G. Wheeled with bumper, fits over 1" O.D. Tubing

193-144

193-145

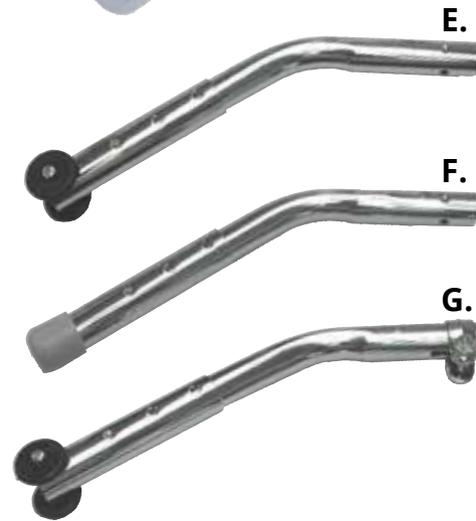

Super-Hemi Rear Anti-Tippers

These anti-tippers fit most any standard super-hemi frames with 7/8" tubing. Fit on the outside of tubing.

Push Button Anti-Tipper

- I. Wheeled, 1" Drop **193-118 \$42.18 a pair**
- J. Wheeled, No Drop **193-123 \$28.20 a pair**

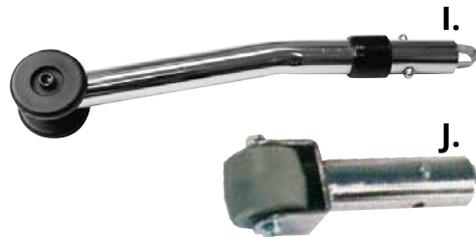

Note: Anti-tippers with push buttons may need holes drilled in the wheelchair frame. If you need any help finding the anti-tipper you need please call 800-328-5343 and a customer service representative will be happy to assist you.



Universal Fit Adjustable Height Rear Anti-Tipper

This innovative design eliminates piles of mismatched anti-tippers because these fit $\frac{3}{4}$ ", $\frac{7}{8}$ " or 1" tubing. They feature infinite height adjustment and 2" easy gliding wheels. No more too high, too low or wrong mounting style!

Universal Anti-Tipper **193-151** **\$42.86**



Quick Adjust Universal Rear Anti-Tipper

Universal rear anti-tipper with a 2" wheel in black. Clamp on with quick pull pin height adjustment. Fits $\frac{3}{4}$ ", $\frac{7}{8}$ " or 1" tubing.

Quick Adjust Anti-Tipper **193-103** **\$32.50**



Front Anti-Tippers

This product prevents patients from tipping forward on the wheelchair. Fits on $\frac{7}{8}$ " and 1" O.D. tubing.

Front Anti-Tippers **\$55.95**
 $\frac{7}{8}$ " O.D. Tubing **193-102**
 1" O.D. Tubing **193-119**



Adjustable Front Anti-tippers

Features:

- > Fits both $\frac{7}{8}$ " and 1" frame diameter
- > Made from durable powder coated steel tubing and heavy gauge chrome plated steel
- > 2" easy gliding wheels
- > Mounting hardware and easy to follow installation instructions included
- > Five height adjustments; fits full height to low hemi chairs

Anti-Tippers **193-156** **\$63.33 a pair**



Adjustable Anti-Theft Bar

This device prevents the wheelchair from folding up. It works on wheelchairs from 16" to 24" wide.

Anti-Theft Bar
 16" to 20" Wide **199-109** **\$15.32**
 22" to 24" Wide **199-110** **\$16.72**

Wheelchair I.V. Poles and Oxygen Holders



A. I.V. Pole

Fits most standard chairs, I.V. pole is adjustable

198-100 \$31.00

B. Oxygen Tank Holder

Fits most standard chairs, oxygen holder is for D-E size cylinders

198-200 \$48.39

C. I.V. Pole and Oxygen Tank Holder

Fits most standard chairs, adjustable in height, oxygen holder is for D-E size cylinders

198-300 \$47.40

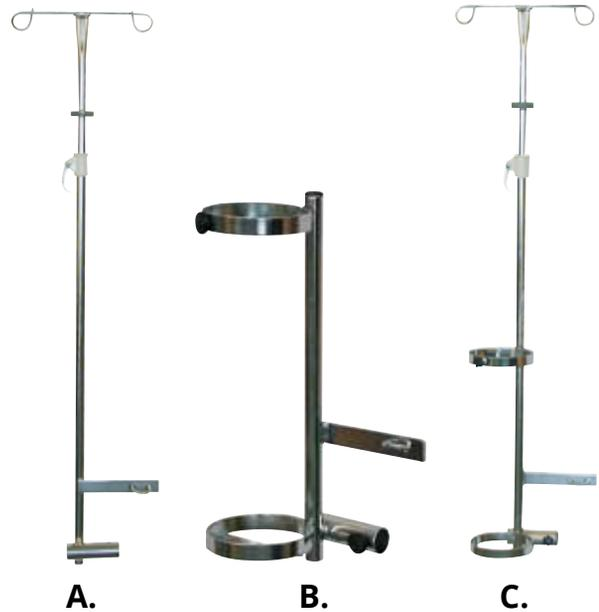

Universal Wheelchair Brake Extensions

Elastic Cord

The elastic cord connects the extension to the brake. This helps to hold the extension on the brake.

A. Without Elastic Cord

\$4.95

- 6" Extension with 1/8" Slot Size **154-102**
- 6" Extension with 3/16" Slot Size **154-105**
- 8" Extension with 1/8" Slot Size **154-101**
- 8" Extension with 3/16" Slot Size **154-104**
- 10" Extension with 1/8" Slot Size **154-100**
- 10" Extension with 3/16" Slot Size **154-103**

B. With Elastic Cord

\$7.95

- 6" Extension with 1/8" Slot Size **154-108**
- 6" Extension with 3/16" Slot Size **154-111**
- 8" Extension with 1/8" Slot Size **154-107**
- 8" Extension with 3/16" Slot Size **154-110**
- 10" Extension with 1/8" Slot Size **154-106**
- 10" Extension with 3/16" Slot Size **154-109**



Push/Extension Handles

Features:

- › Fits over 7/8" O.D. tubing with tubing clamps
- › Made with 16-gauge chrome plated steel
- › Padded with dense black foam
- › Designed to reduce strain on caregivers back and wrists
- › Easier to push chairs up and down hills and stairs

Push/Extension Handles 193-130 \$35.95

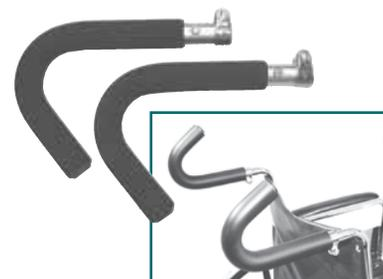

Transfer Belt

These belts provide a secure method of assisting clients during gait training and transfer activities. Belt has a 2" metal buckle and made of heavy-duty cotton webbing.

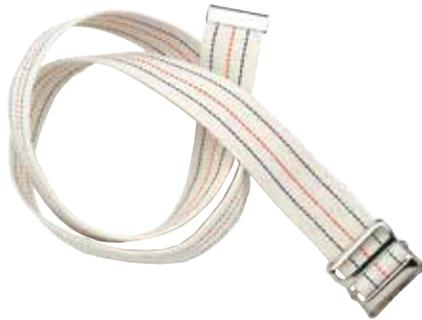

Transfer Belts

48" long	305-130	\$8.25
54" long	305-140	\$8.70
60" long	305-150	\$9.15
72" long	305-160	\$9.60

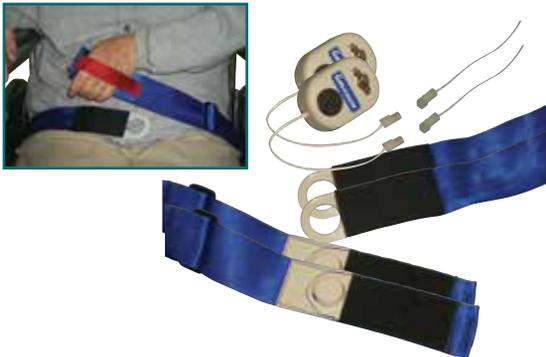

Alarmed Velcro Seat Belt

This product is ideal for the patient who needs the reminder of a velcro lap belt but who, upon request, is able to release the belt. At the instant the belt is separated, an alarm sounds reminding the patient to remain seated. The sound of the alarm also alerts the staff of a potential fall. The seat belt features a red pull strap to facilitate locating and releasing the belt. The rugged alarm unit features 95db. horn and stainless steel mounting clip. A 9 volt battery is included.

Seat Belt	193-134	\$83.33
------------------	----------------	----------------

Safety Belt & Cuff

The patented cuff provides added safety. Eliminates easy access to the velcro closure ensuring fewer accidents. Mounts beneath upholstery screws on back of chair. Special sizes upon request.



Safety Belts and Cuff

Wheelchair Belt 60"	\$12.10
	190-100-CL
Wheelchair Belt 72"	\$12.10
Geri-Chair 72"	190-101-CL
	190-102-CL

See Page 43 for Web Colors



Butterfly Safety Belt

Made with 1½" web, 1½" plastic side release buckles and Naugahyde. Attaches to wheelchair beneath upholstery screws or screws to solid backs. Ideal for patients needing extra support while sitting in chair. Specify color of Naugahyde and webbing when ordering. Special sizes available.

Butterfly Safety Belt

Small	\$31.65
Medium	190-117-CL
Large	190-118-CL
	190-119-CL

See Page 158 for Naugahyde Colors

Safety Belts

Made with long wearing web materials. Choose between a simple two piece belt with velcro buckle, plastic buckle or auto buckle. Equipped with your choice of ends to attach to wheelchair, axle mount or beneath upholstery screws. The belts come in three standard sizes, special sizes are available upon request. Specify color of webbing when ordering your belts.

Note: Length of belt includes 18" for back of wheelchair.
Example: Actual length of 60" belt is only 42".

Velcro Buckle

A. Axle Mount

	\$12.85
60" Belt	190-129-CL
72" Belt	190-130-CL
90" Belt	190-131-CL

B. Upholstery Screw Mount

	\$12.05
60" Belt	190-111-CL
72" Belt	190-103-CL
	\$12.75
90" Belt	190-113-CL

Plastic Safety Buckle

C. Axle Mount

	\$13.35
60" Belt	190-126-CL
72" Belt	190-127-CL
90" Belt	190-128-CL

D. Upholstery Screw Mount

	\$12.55
60" Belt	190-112-CL
72" Belt	190-124-CL
90" Belt	190-125-CL

Auto Buckle

E. Axle Mount

	\$19.90
60" Belt	190-116-CL
72" Belt	190-120-CL
90" Belt	190-121-CL

F. Upholstery Screw Mount

	\$19.10
60" Belt	190-104-CL
72" Belt	190-122-CL
90" Belt	190-123-CL



New style safety buckle



Deluxe Wheelchair Transfer Board



Features:

- › Transfers easily from wheelchair, bed, chair, or toilet
- › Cut out handle for easy carrying
- › Made of urethane sealed; coated and polished hardwood
- › Weight Capacity: 400 lbs.



Features:

- › Unique design for easy transfer
- › Lightweight and easy to handle
- › Made of heavy-duty white plastic
- › Weight Capacity: 500 lbs.



Features:

- › Transfers from wheelchair to bed, car seat, bath board, etc.
- › Made of multi-laminated birch plywood with a smooth lacquer finish
- › Ends are tapered and edges are rounded for easily sliding on and off
- › Weight Capacity: 500 lbs. and 700 lbs.

Transfer Boards

8"x30" Wood with Handle	199-100	\$32.25
8"x27½" Plastic	199-101	\$16.28
9"x29" Wood	199-113	\$78.95
12"x29" Wood	199-114	\$82.24

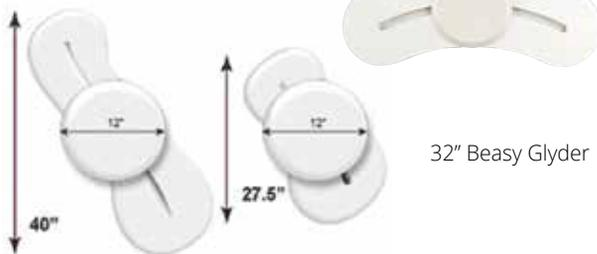

32" Beasy Glyder

Beasy Trans

Specifications:

Length:	40" ETS	27½" Beasy II	32" Beasy Glyder
Width:	12" seat		10" seat
Thickness:	1" base	½" seat	
Weight Capacity:	400 lbs.	400 lbs.	400 lbs.
Seat Rotation:	360°	360°	360°

Beasy Trans

27½" Beasy II	199-108	\$209.21
32" Beasy Glyder	199-119	\$215.79
40" ETS	199-107	\$222.37
Carrying Case	199-120-SZ	\$33.25





Ramps

- 3 lb, 34"x6½" Usable Size **199-980 \$45.50**
- 5 lb, 34"x9½" Usable Size **199-981 \$64.75**
- 5½ lb, 34"x12" Usable Size **199-982 \$72.00**
- 8 lb, 34"x17" Usable Size **199-983 \$88.50**

Threshold Ramps

Lightweight yet free-standing modular ramp designed for doorways, sliding glass doors and raised landings. This seam-free ramp is 34" wide and easily accommodates thresholds from ¾" to 6" high. Made of anodized aluminum and is intended for indoor and outdoor use.

Features:

- › All aluminum construction
- › Anti-skid surface
- › Weight capacity: 600 lbs.

- 11 lb, 34"x22¼" Usable Size **199-984 \$103.50**
- 15 lb, 34"x27½" Usable Size **199-985 \$129.00**
- 20 lb, 34"x32¾" Usable Size **199-986 \$145.07**

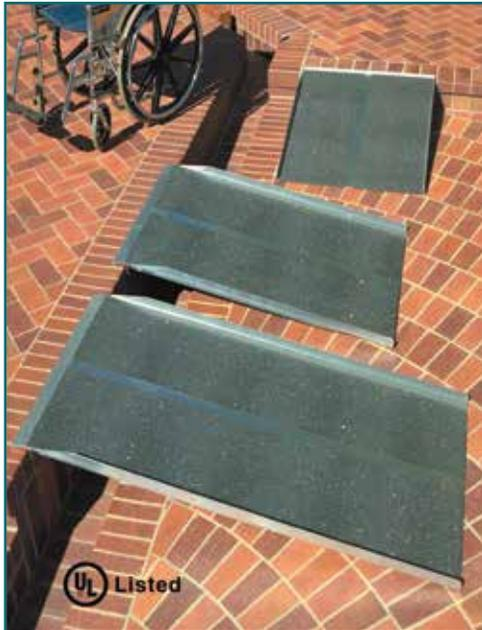

Curb Ramps

This ramp is designed as a semi-permanent ramp for use in areas in which portability is not an issue. Simply put the ramp in place and leave it there.

Features:

- › All Aluminum Structure
- › Weight capacity: 600 lbs.

Ramps

- 30"x36" Usable Size **199-933 \$144.42**
- 30"x48" Usable Size **199-935 \$187.05**
- 30"x60" Usable Size **199-937 \$224.36**
- 36"x36" Usable Size **199-940 \$168.11**
- 36"x48" Usable Size **199-942 \$161.06**
- 36"x60" Usable Size **199-944 \$260.47**



Single Fold Carry Ramps

This ramp is designed to help you overcome curbs or small steps. Designed to fold in half with an easy to carry handle, this ramp is an economic answer for the person on the go. Ideal for use in many vans.

Features:

- › All aluminum structure
- › Anti-skid surface
- › Carrying handle
- › Safety rails on each side
- › Folds to half it's width
- › Weight Capacity: 600 lbs.

Ramps

- 10 lb, 30"x24" **199-920 \$113.73**
- 15 lb, 30"x36" **199-921 \$127.23**
- 20 lb, 30"x48" **199-922 \$164.55**
- 24 lb, 30"x60" **199-923 \$196.53**



Adjustable Stop Banner

This durable coated nylon banner presents an imposing visual barrier. It's sure to deter wandering residents from entering restricted areas. Adjustable up to an opening of 60" wide. Two or more can be easily joined to span wider openings. Attaches with the provided velcro or screws.

Adjustable Stop Banner **193-135** **\$26.67**



Fall Prevention Monitor

The Safe•t Mate fall prevention monitor has been designed to overcome the pitfall of others on the market. Many monitors are expensive yet unreliable. One fall and they break. Some are less costly but are not designed or intended to be used as patient fall monitors. This monitor incorporates durability & versatility into an attractive, remarkably economical package. Features include: 1) Custom stainless clip that mounts to bed, wheelchair or walker without the need for additional mounting hardware, 2) Slide cord that adjusts for chair or bed use, 3) Pull away magnetic disc design allows for a variety of mounting positions. A 9 volt battery is included.

Fall Prevention Monitor **193-132** **\$25.00**



No more Disposable Sensor Pads!

Under-Seat Wheelchair Fall Monitoring System

Typical sensor pad systems are fraught with problems such as; limited life from wear, kinking, shifting out of position, and the infection control issue of exposure to fluids. The unique location of the Safe•t mate under-seat sensor unit eliminates all of these problems and there is nothing disposable about it, which makes it extremely cost-effective! Our complete system, which includes the under-seat sensor and the alarm unit, is less expensive than some disposable sensor pads alone! Beyond this, the under seat unit is guaranteed for life from manufacturing defects! The under-seat unit is fully adjustable to fit any width wheelchair and is compatible for use with seat cushions. The detachable alarm box features a full size on/off switch and a 95 db horn. A 9 volt battery and easy to follow installation instructions are included.

Fall Monitor **193-155** **\$83.33**

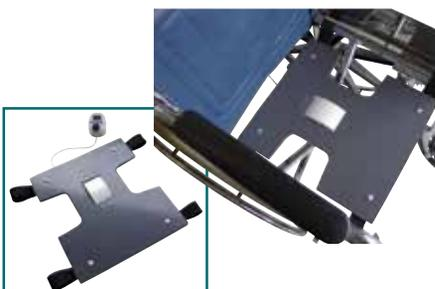

Adjustable Drop Seat with Integrated Alarm

Start with a fully adjustable solid drop seat suspended by steel hangers for custom positioning. Add an integrated alarm unit for fall prevention and you arrive at the ultimate package, All in one! Add to this, the alarm switching mechanism is Guaranteed For Life! A cost effective alternative to disposable sensor pad systems. The rugged alarm unit features a 95db horn and stainless steel mounting clip. A 9 volt battery is included.

Drop Seat with Alarm **193-133** **\$107.14**

The Wheelchair Anti-Rollback Device

This patented device is the industry standard for thousands of facilities nationwide. The device works completely by spring tension. A padded lever beneath the seat is depressed when the occupant is seated. This lever is connected to a pair of stainless steel brake arms that are held just off the surface of the rear tires. As the occupant begins to lift weight from the seat, the spring force causes the lever to rotate upward, in turn the brake arms rotate down to engage the tires. The greater the rearward force on the chair, the greater the braking power. The design is discreet and blends into the chair to become a dignified, non-punitive fall intervention. Heavy seat cushions are not a problem because each anti-rollback device includes an easy to install kit that compensates for the additional cushion weight. The chair can be collapsed for transport or storage. The standard device fits chairs 16"-20" wide and from full to hemi height. A 9 volt battery is included.



Anti-Rollback Device

Standard	193-136	\$142.86
22" and 24" Wide Chairs	193-129	\$142.86
With Ambulation Monitor	193-137	\$197.37

Wheelchair I.D. System

This product manages the problems associated with patient specific wheelchair requirements. New employees or staff who float are unfamiliar with the accessories required on particular wheelchairs. This system records all pertinent information on a removable vinyl sticker adhered to an easy to install bracket. 10 brackets with roll of 50 labels.



I.D. System **193-131** **\$20.00**



CHECK OUT OUR NEW WEBSITE
WheelchairParts.com

Other Catalogs Available
 Call us for your Free Parts Catalog
Toll Free: 800-328-5343





**Only
\$15.95**



Ocelco Pull String Monitor

The newly redesigned Ocelco string monitor provides unparalleled value that is rich in features and low in cost. The case is constructed of a durable ABS plastic that can withstand the rigors of institutional use. All the alarm settings are located inside the battery compartment making the monitor compliant with JCAHO standards. The mounting clip is now made of an indestructible stainless steel and is Guaranteed Not To Break! The pull cord is adjustable in length. A new unique alarm tone provides differentiation from other alarms in the facility, such as door or wandering alarms. The battery compartment features a hinged design that is permanently attached to the case. No more lost battery covers! The cover also features a dual function closure, including a snap-to-close design as well as a screw for increased tamper resistance.

	Reg.	Sale
Pull String Monitor	305-461 \$19.14	\$15.95
Replacement Magnet Assembly, 5 pk	305-463 \$35.98	\$29.98



Ocelco Basic Alarm with Choice of Pad

The new Basic Monitor features an Off/Lo/Hi switch on the side of the monitor to control alarm function. A strain relief helps to protect both the monitor and the sensor pad connector from damage. The Basic monitor is an excellent entry level upgrade from string monitors.

Basic Alarm	Reg.	Sale
with 45 Day Chair Pad	305-466-4C \$59.78	49.82
with 1 Year Chair Pad	305-466-1C \$75.14	62.62
with 45 Day Bed Pad	305-466-4B \$64.74	53.95
with 1 Year Bed Pad	305-466-1B \$82.04	68.37



Ocelco Advanced Alarm with Choice of Pad

The New Advanced Monitor has many features including: Hi/Lo/ Remote alarm volume, 0-2 second alarm delay, Optional AC adaptor, built in strain relief helps to protect the monitor and sensor pad connector from damage. Reset button is discretely located on the side of the monitor. All alarm controls are located inside the battery compartment making the monitor compliant with JCAHO standards.

Advanced Alarm	Reg.	Sale
with 45 Day Chair Pad	305-467-4C \$74.64	\$62.20
with 1 Year Chair Pad	305-467-1C \$90.00	\$75.00
with 45 Day Bed Pad	305-467-4B \$79.60	\$66.33
with 1 Year Bed Pad	305-467-1B \$96.90	\$80.75
AC Adaptor for Advanced Alarm	305-464	\$21.10 \$18.33

Universal Chair Exit Alarm Pads

The Universal Sensor Pad is compatible with most brands of fall monitors. Pad measures 14.5" wide x 10" deep.

***Note:** It is the caregiver's responsibility to test monitor compatibility with Universal Sensor Pads.

Universal Chair Pads

		Reg.	Sale
45 Day Chair Pad	305-457-CH	\$18.54	\$15.45
1 Year Chair Pad	305-458-CH	\$33.90	\$28.25
45 Day Chair Pad, 6 Pack	305-468-CH	\$95.99	\$79.99
1 Year Chair Pad, 6 Pack	305-469-CH	\$182.51	\$155.99



Universal Bed Exit Alarm Pads

The Universal Sensor Pad is compatible with most brands of fall monitors. Pad measures 28.25" wide x 10" deep.

***Note:** It is the caregiver's responsibility to test monitor compatibility with Universal Sensor Pads.

Universal Bed Pads

		Reg.	Sale
45 Day Bed Pad	305-457-BD	\$23.50	\$19.58
1 Year Bed Pad	305-458-BD	\$40.80	\$34.00
45 Day Bed Pad, 6 Pack	305-468-BD	\$143.99	\$119.99
1 Year Bed Pad, 6 Pack	305-469-BD	\$220.79	\$183.99



Shock Absorber for Ocelco Exit Alarms

The Shock Absorber is designed to absorb the impact from accidental droppings. Helps to greatly increase the life expectancy of Ocelco Exit Alarms. Fits all Ocelco Exit Alarms.

Shock Absorber

		Reg.	Sale
	305-462	\$7.98	\$6.65



Universal Mounting Clip for Head and Footboards

Fits all Ocelco Exit Alarms.

Mounting Clip

		Reg.	Sale
	305-465	\$9.98	\$8.32



AC Adaptor for Ocelco Advanced Alarm

Only works with the Ocelco Advanced Fall Prevention Alarms

AC Adaptor

		Reg.	Sale
	305-464	\$21.10	\$18.33



Wrap Around Armrest Pads



Made with, 1½" foam, 2" velcro, and ties for attaching to arms. Aids in positioning of the patient.

Armrest Pads	\$42.39
Full Arm	194-5CL
Desk Arm	194-6CL

Specify color from page 158

Arm Trough



- › Desk Arms 9"x5"x5"
- › Full Arms 12"x5"x5"
- › Special sizes available upon request

Armrest Pads	\$50.05
Full Arm	194-8CL
Desk Arm	194-7CL

Specify color from page 158



Lumbar Pad

Lumbar Pad	\$36.47	703-205-CL
-------------------	----------------	-------------------

Specify color from page 158



Headrest Pad

Made with Naugahyde, 15½" wide x 5" tall x 6" deep foam, 1½" web straps and velcro for attaching to chair.

Headrest	202-4CL	\$58.13
-----------------	----------------	----------------

Specify color from page 158



Wheelchair Headrest Extension

Made with Naugahyde, 1" foam and chrome plated mounting hardware. Mounts beneath top two upholstery screws on the back of most wheelchairs. Adjustable height.

Headrest Extension	\$49.95
Narrow Adult 16"	197-1CL
Standard Adult 18"	197-2CL
Flare Back 20"	197-3CL

Specify color from page 158



Wheelchair and Walker Pouches

Features:

- › Made with Naugahyde
- › Durable and inexpensive
- › Great for carrying personal items or patient charts

Wheelchair and Walker Pouches

A. Deluxe Wheelchair Pouch	192-2CL	\$17.80
B. Econo Wheelchair Pouch	192-1CL	\$13.40
C. Walker Pouch	249-1CL	\$17.80

Specify color from page 158

Heel and Toe Loops

Heel and Toe Loops

Econo Heel Loop	196-102	\$3.55
Heel Loop	196-100-CL	\$4.95
Padded Heel Loop	196-101-CL	\$6.70
Toe Loop	196-200-CL	\$5.35
Padded Toe Loop	196-201-CL	\$6.70



Specify color from page 158

Padded Footplates

- › Made with 1" foam
- › Attaches with velcro to footrests
- › Fits standard footplates
- › Special sizes available upon request



Padded Footplates **196-4CL** **\$27.76 a pair**

Specify color from page 158

H-Strap Belt

Made with long wearing web material. Prevents feet from falling behind footplates and causing serious pain or injury to patient. Special sizes available upon request.



H-Strap Belt

16-18" Wide Chairs	196-300-CL	\$17.95
20" Wide Chairs	196-301-CL	\$17.95
22" Wide Chairs	196-302-CL	\$17.95

Specify color from page 158

Shoe Holders and Foot Board



Shoe Holders

Small	706-600	\$85.00
Medium	706-601	\$85.00
Large	706-602	\$85.00

Foot Board

Wood	706-603	\$106.25
------	----------------	-----------------

Footrest Pads

Made with 1/2" foam. Attaches to footrests with velcro straps or metal hooks. Velcro style is universal to fit all standard chairs. Hook on is made for 18" wide chairs. Special sizes available upon request.

Footrest Pad

Velcro	191-1CL	\$27.37
Hooks	196-202-CL	\$28.31

Specify color from page 158



Padded Calf and Foot Board

Made with 1" foam and 1/2" wood. Attaches to footrests with buckles. Fits standard 18" wide chairs. Special sizes available upon request.

Calf and Foot Board **196-5CL** **\$81.71**

Specify color from page 158



Drainage Bag Covers and Holder

Holder mounts beneath two upholstery screws on back of wheelchair. Adjustable arm for folding chair.

Drainage Bag Covers and Holder

A. Cover and Holder	194-1CL	\$14.21
B. Bard Bag Cover (Bard Bag #802001)	194-2CL	\$12.60

Specify color from page 158





A.

Full Size Wheelchair Trays

One size fits all adult and junior wheelchairs. Velcro straps fasten tray securely to any style arm. Three styles to choose from.

Trays

A. Wood (24"x20"x1½")	195-100	\$29.55
B. Acrylic (23"x19"x¼")	195-103	\$57.65
C. Padded (24"x20"x1")	195-2CL*	\$75.95

*Choose color and material from page 158

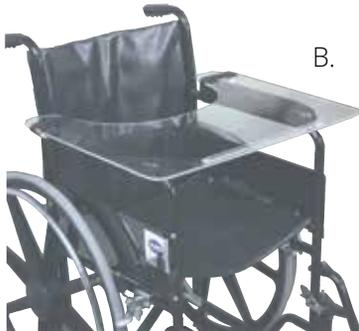

B.

C.



A.

Lap Huggers

Posey

This soft lap cushion fits snugly between the resident and the wheelchair frame to facilitate upper body positioning and helps prevent forward leaning.

A. Standard

16"-18" Wide Wheelchair, 4" Thick, Full Arm, Blue	195-116	\$48.40
16"-18" Wide Wheelchair, 4" Thick, Full Arm, Mauve	195-118	\$48.40
16"-18" Wide Wheelchair, 3" Thick, Full Arm, Blue	195-117	\$48.40
20"-24" Wide Wheelchair, 4" Thick, Full Arm, Blue	195-113	\$65.20

B. Desk Arm

18"-20" Wide Wheelchair, 3" Thick, Desk Arm, Blue	195-114	\$52.25
---	----------------	----------------

C. Self-Release

18"-20" Wide Wheelchair, 3" Thick, Desk or Full Arm, Blue	195-119	\$52.33
---	----------------	----------------

D. Tabletop

18" Wide Wheelchair, 4" Thick, Full Arm, Blue	195-112	\$66.50 DISC.
---	----------------	----------------------

E. E-Z Release

18"-20" Wide Wheelchair, 3" Thick, Desk or Full Arm, Blue	195-120	\$57.78
---	----------------	----------------



B.



C.



E.



D.

Clip On Cup Holder

Features:

- › Notched for mugs, as well as cups and glasses
- › Plastic coated steel spring clip
- › Fits wheelchairs, beds, and tubular furniture
- › 2¾" at bottom tapers to larger opening at top
- › Height is 3½"



Cup Holder **275-158** **\$11.50**

Folding Drink Holder

Features:

- › Holds cups, cans, and bottles
- › Snaps onto upright of wheelchairs, walkers, and canes
- › Holds 8 oz. to 44 oz. containers
- › Folds to ½" thick
- › Made of high density polypropylene



Drink Holder **275-108** **\$28.08**

Wheelchair Umbrella

Features:

- › Provides rain and sun protection
- › Fits most wheelchairs
- › Fully adjustable stem
- › Umbrella measures 40" in diameter
- › Length including adjustable stem is 36"



Umbrella **275-180** **\$29.55**

Universal Cup Holder

Features:

- › New clamp allows cup holder to swivel to keep contents level
- › Easily attaches to wheelchairs, rollators or walkers with tubing diameter from 5/8" to 1"
- › Dimensions: 3" (L) x 3" (W)



Cup Holder **275-160** **\$14.95**

Ring Cushion

- › 16" Inflatable Vinyl Ring
- › 20 gauge heavy-duty vinyl
- › Unique Roberts valve for easy inflation



Vinyl Ring **206-900** **\$6.10**

Wheelchair Pad

- › Provides soft support and pressure relief
- › Prevents sliding which promotes correct positioning

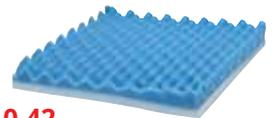

Wheelchair Pad

2" (standard) **206-519** **\$10.42**
 3" **206-520** **\$13.33**

Inflatable Rubber Ring

- › Top quality rubber
- › Special valve designed for easy inflation



Rubber Ring **206-901** **\$12.62**

Wheelchair Cushion with Back Support

Promotes good posture while providing proper support

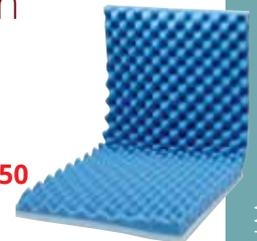

Wheelchair Cushion **206-521** **\$17.50**

Eggcrate® Convulated Overlays

Distributes body weight evenly, reduces pressure and promotes air circulation for enhanced comfort.

Wheelchair Pad

16"x18"x4" **\$6.35**
 191-011

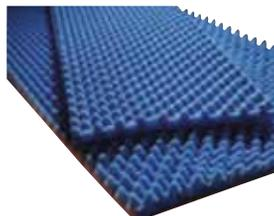

Other sizes available upon request

Seat and Back Cushion



Cushions

Standard **191-041** **\$85.71**
 Reclining **191-044** **\$137.96**

Aire-Elite™ Wheelchair Cushion



Aire-Elite Cushion

2" **707-535-SZ-CL \$208.57**
 4" **707-536-SZ-CL \$223.57**

Constructed of flame resistant neoprene encased natural rubber for flexibility, comfort, and safety. Tri-Laminate construction provides puncture resistance and overall durability while maintaining superior flexibility and softness. A fitted low shear moisture-resistant, anti-fungal, anti-bacterial cover with a non-skid bottom is washable.

Molded Wheelchair Seat Cushion



- › A unique construction of High Resilient molded foam provides optimum stabilization, position, pressure reduction and seating posture
- › Cover has a "Non-Slip" bottom for comfort and safety
- › Designed for clients who are at low risk for skin breakdown
- › Stretch polyester knit cover is removable, washable and flame retardant

Molded Wheelchair Seat Cushion

18" x 16" **191-084 \$24.95**

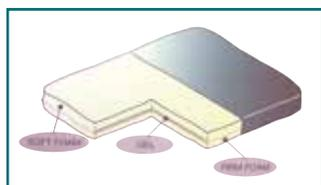

Standard Gel Cushion

- › Maximum comfort, stability and therapeutic effectiveness
- › Combination of firm and soft foam with gel
- › Reversible for comfort level
- › Size: 18"x16"x2"

Gel Cushion

Grey Velour Cover
 Black Waterproof and Fire-Retardant Cover

191-054 \$31.09
191-068 \$30.92



Gel Foam Wheelchair Seat Cushion



- › Cover top is water resistant and vapor permeable
- › Designed for clients who are at low risk for skin breakdown
- › Pressure reduction cushion designed to assist in the prevention, treatment and management of pressure ulcers
- › Removable and replaceable cover that is zippered, constructed as follows:
- › Cover top is a urethane coated nylon; Base is vinyl for durability
- › Viscous gel-bladder provides optimum support and comfort

Cushion

Gel Foam Wheelchair Seat Cushion **191-086 \$31.03**

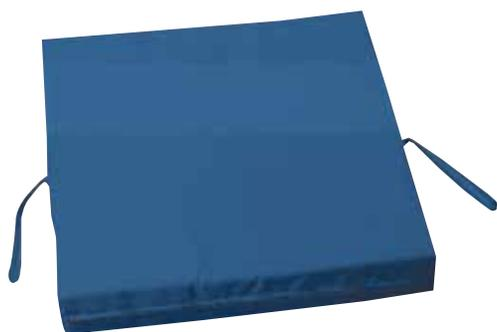

Premium Guard Gel "E" Seat Cushion

- › A pressure reducing cushion designed to assist in the prevention of pressure sore ulcer
- › Viscous Gel provides maximum support and comfort
- › Fire retardant polyurethane foam shell

Cushion

16"x18"x3" **191-087 \$35.95**
 16"x16"x3" **191-082 \$36.95**



Posey

GSS Cushion

The Posey GSS Cushion has been designed with a gentle contour to protect against skin breakdown, provide comfort, and reduce forward sliding. Constructed of comfortable and durable polyurethane foam, the GSS Cushion has been designed so that it's edges can rest on the wheelchair frame. Flat bottom provides a level seating surface. SoffTICK Supreme cover is a durable, comfortable and waterproof 4-way stretch material with a non-skid bottom to prevent the cushion from sliding forward. Meets CA#117 flame retardancy standards.

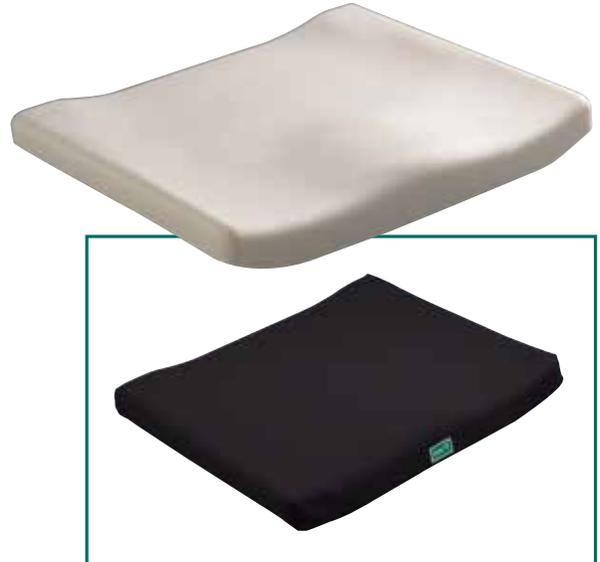

Cushion	\$69.95
16"x16"x2"	191-095
16"x18"x2"	191-096
18"x16"x2"	191-097
18"x18"x2"	191-098
20"x18"x2"	191-099

Posey

GSS Deluxe Cushion

Posey GSS Cushion incorporate LiquiCell bladder technology that offers superior protection against shear and friction. The low viscosity fluid filled bladders are incorporated into the cushion cover and utilize a series of strategically placed baffles that controls the flow of the fluid helping to dramatically reduce tissue shear stress. The GSS Deluxe Cushion's gentle contour provides comfort and helps reduce forward sliding, and is constructed of comfortable and durable molded polyurethane foam. The cushion has been designed so that it's edges can rest on the wheelchair frame while the flat bottom provides a level seating surface. The SoffTICK Supreme's cover is a durable, comfortable, and waterproof 4-way stretch material with a non-skid bottom to prevent the cushion from sliding forward. Meets CA#117 flame retardancy standards.



Cushion	\$94.95
16"x18"x2"	191-091
18"x16"x2"	191-092
18"x18"x2"	191-093
20"x18"x2"	191-094

Standard Cushion

The standard cushion adds comfort to any chair, choose between 2" or 3" thickness. Foam is fire retardant. Choose your covering. This cushion is universal to fit most standard adult 18" and narrow adult 16" wheelchairs. The cushion comes with ties for securing to back of chair.

Standard Cushion

16"x16"x2"	192-4CL	\$35.05
18"x16"x2"	192-3CL	\$35.05
16"x16"x3"	192-8CL	\$39.30
18"x16"x3"	192-7CL	\$39.30

*Choose color and material from page 158

Contoured Cushion

The Contoured Cushion is used to take the hammock out of the seat, choose between 2" or 3" thickness. Made with closed cell foam and standard fire retardant foam. Choose your covering. This cushion is universal to fit most standard adult 18" and narrow adult 16" wheelchairs. The cushion comes with ties for securing to back of chair.

Contoured Cushion

16"x16"x2"	190-7CL	\$51.95
18"x16"x2"	190-5CL	\$51.95
16"x16"x3"	190-8CL	\$53.95
18"x16"x3"	190-6CL	\$53.95

*Choose color and material from page 158

Wedge Cushion

The wedge cushion helps prevent patient from sliding forward, choose between three different slants, 1" to 3" slant, 2" to 4" slant or 3" to 6" slant. Foam is fire retardant. Choose your covering. This cushion is universal to fit most standard adult 18" and narrow adult 16" wheelchairs. The cushion comes with ties for securing to back of chair.

Wedge Cushion

16"x16" with 1" to 3" Slant	191-4CL	\$41.80
16"x16" with 2" to 4" Slant	191-6CL	\$44.50
16"x16" with 3" to 6" Slant	191-8CL	\$47.20
18"x16" with 1" to 3" Slant	191-5CL	\$41.80
18"x16" with 2" to 4" Slant	191-7CL	\$44.50
18"x16" with 3" to 6" Slant	191-9CL	\$47.20

*Choose color and material from page 158

Abductor Cushion

The abductor cushion helps position patient and prevents patient from sliding forward. Foam is fire retardant. Choose your covering. This cushion is universal to fit most standard adult 18" and narrow adult 16" wheelchairs. The cushion comes with ties for securing to back of chair.

Abductor Cushion

16"x16"x3"	192-6CL	\$55.30
18"x16"x3"	192-5CL	\$55.30

*Choose color and material from page 158



Build-A-Cushion

Have a special request? We'll Customize it for you!

Build a cushion to meet your needs and specifications. If there is an option or size you are looking for and it is not listed below, please call and we will be happy to quote you a price and build your cushion today!

Note: No returns on custom built cushions, for more details on returns see company policy on front inside cover.

*Choose color and material from page 158



Build Your Part Number Below

CU	Size	Gel Insert	Bottom Style	Top Shape	Thickness	Foam Type	Wood Base	Covering Code See page 158

Size

1 = 16"x16"	N/C
2 = 18"x16"	N/C
3 = 20"x16"	+\$7.75
4 = 18"x18"	+\$7.75
5 = 20"x18"	+\$11.80
6 = 22"x18"	+\$14.50
7 = 24"x18"	+\$17.20

Gel Insert

1 = No Gel Insert	N/C
2 = Gel Insert	+\$40.50

Bottom Style

1 = Flat	N/C
2 = Contoured	+\$17.20
3 = Flat, No Slip Fabric	+\$6.75
4 = Contoured, No Slip Fabric	+\$22.95

Top Shape

1 = Flat	N/C
2 = Abductor Pad	+\$17.55

Thickness

1 = 1" Thick	Base Price \$35.05
2 = 1½" Thick	\$35.05
3 = 2" Thick	\$35.05
4 = 3" Thick	\$37.75
5 = 4" Thick	\$40.45
6 = 1" to 3" Wedge	\$41.80
7 = 2" to 4" Wedge	\$44.50
8 = 3" to 6" Wedge	\$47.20

Foam Type

1 = Standard Foam (Fire Retardant)	N/C
2 = ½" T-Foam and Standard Foam	+\$15.00
3 = 1" T-Foam and Standard Foam	+\$25.00

Wood Base

1 = No Wood Base	N/C
2 = ½" 9 ply Marine Grade Plywood Base	+\$9.00

Ocelco's Gel-Foam Folding Cushion

- › Comes with built in strap to prevent folding cushion from moving or falling off the wheelchair
- › Support factor improved by 40%
- › Improved pressure point relief
- › Increasing support for recessed parts of the body
- › Superior weight distribution and durability
- Heat conductivity improved by 30%
- › Open cell design supports air (heat) & moisture movement
- › Improving blood flow and oxygen exposure to skin cells



Gel-Foam Folding Cushion

18"x16"x2" **192-OCL \$47.20**

Call Our Toll Free Customer Service to Find Out Pricing For A Custom Size

*Choose color and material from page 158

ROHO Positioning and Therapeutic Seating System Products



The MOSAIC cushion is especially suited for users who require a cushion for basic level skin protection, support and comfort. Using air flotation technology, the MOSAIC cushion is not only comfortable, but the use of interconnected air cells to distribute forces evenly across the cushion allows it to be used effectively for low risk skin protection. The Roho Mosaic 3" polyvinyl Cushion has interconnected air cells that are easy to setup, inflate and adjust. The Roho Mosaic is designed to provide a comfortable, functional and stable sitting environment. Washable, incontinent cover included.

Mosaic 3" Polyvinyl Cushion **\$104.00**
Specify size when ordering (i.e. 16" x 16") **707-138-SZ**



For individuals who require special positioning of the pelvis or thighs and risk of skin breakdown, the Quadro, with 4" cell height and air in place progressive positioning is the cushion of choice. The Quadro cushion with the Isoflap valve open, provides the same therapeutic valve as a single compartment high profile cushion.

Quadro Cushion **\$357.00**
Specify size when ordering (i.e. 16" x 16") **707-501-SZ**



Contour designed for more natural seating position. Promotes pelvic and leg positioning. Comes in 2" cell height.

Pre-Shaped Foam Base Cushion **\$342.00**
Specify size when ordering (i.e. 16" x 16") **707-503-SZ**



With 4" cells, the High Profile is the cushion of choice for individuals who suffer from ischemic ulcers (pressure sores) or who have a history of tissue breakdown.

High Profile Cushion (single valve) **\$397.00**
Specify size when ordering (i.e. 16" x 16") **707-506-SZ**



The Low Profile single compartment cushion with 2" cells offers active users protection against skin breakdown.

Low Profile Cushion (single valve) **\$379.00**
Specify size when ordering (i.e. 16" x 16") **707-507-SZ**



The contoured design combined with the simple operation of the ISOFLO® Memory Control™ Unit provides a new level of postural control and stability that has never been achieved in an air cushion. The contoured design positions the pelvis back in the wheelchair, and centers the user comfortably in the middle of cushion. The ISOFLO Memory Control Unit locks air into each of the four quadrants, providing stability by minimizing side-to-side and front to back motion.

Contour Select Cushion **\$357.00**
Specify size when ordering (i.e. 16" x 16") **707-509-SZ**

Solid Back Insert

Made with Naugahyde, nylon or mesh, 1" foam, and 1/2" wood. 14 1/2"x15 1/2", fits 18" adult wheelchair. Special sizes and materials available upon request.

When ordering specify: Proposed Make of Chair, Proposed Model of Chair, Width of Chair and Armstyle (Removable or Fixed Arms).

Solid Back Insert 701-4CL \$57.75

*Choose color and material from page 158



Standard Drop Hook Back

Made with Naugahyde, nylon, or mesh, 1" foam and 1/2" wood. Fits 18" adult wheelchair. Special sizes and materials available upon request. Black, anodized stainless steel hardware.

When ordering specify: Proposed Make of Chair, Proposed Model of Chair, Width of Chair and Armstyle (Removable or Fixed Arms).

*Choose color and material from page 158



Seat with Standard Clamps

\$125.65

- Fits 7/8" Tubing, 1" Drop **701-200-CL**
- Fits 7/8" Tubing, 1 1/2" Drop **701-216-CL**
- Fits 7/8" Tubing, 2" Drop **701-201-CL**
- Fits 7/8" Tubing, 2 1/2" Drop **701-217-CL**
- Fits 7/8" Tubing, 3" Drop **701-202-CL**
- Fits 1" Tubing, 1" Drop **701-203-CL**
- Fits 1" Tubing, 1 1/2" Drop **701-218-CL**
- Fits 1" Tubing, 2" Drop **701-204-CL**
- Fits 1" Tubing, 2 1/2" Drop **701-219-CL**
- Fits 1" Tubing, 3" Drop **701-205-CL**

Seat with Quick Release

\$129.65

- Fits 7/8" Tubing, 1" Drop **701-210-CL**
- Fits 7/8" Tubing, 1 1/2" Drop **701-220-CL**
- Fits 7/8" Tubing, 2" Drop **701-211-CL**
- Fits 7/8" Tubing, 2 1/2" Drop **701-221-CL**
- Fits 7/8" Tubing, 3" Drop **701-212-CL**
- Fits 1" Tubing, 1" Drop **701-213-CL**
- Fits 1" Tubing, 1 1/2" Drop **701-222-CL**
- Fits 1" Tubing, 2" Drop **701-214-CL**
- Fits 1" Tubing, 2 1/2" Drop **701-223-CL**
- Fits 1" Tubing, 3" Drop **701-215-CL**

Adjustable Drop Hook Back

Made with Naugahyde, nylon or mesh, 1" foam, and 1/2" wood. Fits 18" adult wheelchair. Special sizes and materials available upon request. Black, zinc plated stainless steel hardware.

When ordering specify: Proposed Make of Chair, Proposed Model of Chair, Width of Chair and Armstyle (Removable or Fixed Arms).

*Choose color and material from page 158



Standard Clamp with Adjustable Hooks

\$141.80

- Fits 7/8" Tubing **701-300-CL**
- Fits 1" Tubing **701-301-CL**

Quick Release with Adjustable Hooks

\$145.80

- Fits 7/8" Tubing **701-303-CL**
- Fits 1" Tubing **701-304-CL**

Solid Seat Insert

Made with Naugahyde, nylon, or mesh, ½" foam, and ½" wood. 17½"x15½", fits 18" adult wheelchair. Special sizes and materials available upon request.

When ordering specify: Proposed Make of Chair, Proposed Model of Chair, Width of Chair and Armstyle (Removable or Fixed Arms).

Solid Seat Insert 702-4CL \$47.95

*Choose color and material from page 158



Standard Drop Hook Seat

Made with Naugahyde, nylon, or mesh. ½" foam and ½" wood. Fits 18" adult wheelchair. Special sizes and materials available upon request. Black, zinc plated stainless steel hardware.

When ordering specify: Proposed Make of Chair, Proposed Model of Chair, Width of Chair and Armstyle (Removable or Fixed Arms).

*Choose color and material from page 158



Seat with Standard Clamps

- Fits 7/8" Tubing, 1" Drop
- Fits 7/8" Tubing, 1½" Drop
- Fits 7/8" Tubing, 2" Drop
- Fits 7/8" Tubing, 2½" Drop
- Fits 7/8" Tubing, 3" Drop
- Fits 1" Tubing, 1" Drop
- Fits 1" Tubing, 1½" Drop
- Fits 1" Tubing, 2" Drop
- Fits 1" Tubing, 2½" Drop
- Fits 1" Tubing, 3" Drop

\$120.00

- 702-200-CL**
- 702-216-CL**
- 702-201-CL**
- 702-217-CL**
- 702-202-CL**
- 702-203-CL**
- 702-218-CL**
- 702-204-CL**
- 702-219-CL**
- 702-205-CL**

Seat with Quick Release

- Fits 7/8" Tubing, 1" Drop
- Fits 7/8" Tubing, 1½" Drop
- Fits 7/8" Tubing, 2" Drop
- Fits 7/8" Tubing, 2½" Drop
- Fits 7/8" Tubing, 3" Drop
- Fits 1" Tubing, 1" Drop
- Fits 1" Tubing, 1½" Drop
- Fits 1" Tubing, 2" Drop
- Fits 1" Tubing, 2½" Drop
- Fits 1" Tubing, 3" Drop

\$124.10

- 702-210-CL**
- 702-220-CL**
- 702-211-CL**
- 702-221-CL**
- 702-212-CL**
- 702-213-CL**
- 702-222-CL**
- 702-214-CL**
- 702-223-CL**
- 702-215-CL**

Adjustable Drop Hook Seat

Made with Naugahyde, nylon, or mesh. 1½" foam and ½" wood. Fits 18" adult wheelchair. Special sizes and materials available upon request. Black, zinc plated stainless steel hardware.

When ordering specify: Proposed Make of Chair, Proposed Model of Chair, Width of Chair and Armstyle (Removable or Fixed Arms).

Standard Clamp with Adjustable Hooks

- Fits 7/8" Tubing
- Fits 1" Tubing

\$132.00

- 702-300-CL**
- 702-301-CL**

Quick Release with Adjustable Hooks

- Fits 7/8" Tubing
- Fits 1" Tubing

\$136.50

- 702-303-CL**
- 702-304-CL**



*Choose color and material from page 158

Flip Down Amputee Seats

Made with Naugahyde, nylon, or mesh, 1½" foam and ½" wood. Black, zinc plated stainless steel drop hooks. Fits standard 18" adult wheelchair. Left side, right side or dual pads available.

When ordering specify: Proposed Make of Chair, Proposed Model of Chair, Width of Chair, Armstyle (Removable or Fixed Arms) and Length and Side (Right, Left or Dual) of Amputee Pad. Specify Left or Right when sitting in the chair.

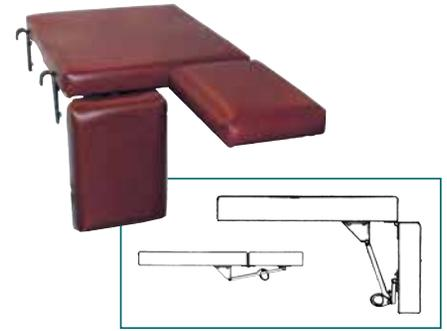

Left Side		Right Side		Dual Pad	
Fixed, Standard Clamp	\$136.35	Fixed, Standard Clamp	\$136.35	Fixed, Standard Clamp	\$152.85
1" Drop, Fits 7/8" Tubing	702-600-CL	1" Drop, Fits 7/8" Tubing	702-616-CL	1" Drop, Fits 7/8" Tubing	702-632-CL
1" Drop, Fits 1" Tubing	702-601-CL	1" Drop, Fits 1" Tubing	702-617-CL	1" Drop, Fits 1" Tubing	702-633-CL
2" Drop, Fits 7/8" Tubing	702-604-CL	2" Drop, Fits 7/8" Tubing	702-620-CL	2" Drop, Fits 7/8" Tubing	702-636-CL
2" Drop, Fits 1" Tubing	702-605-CL	2" Drop, Fits 1" Tubing	702-621-CL	2" Drop, Fits 1" Tubing	702-637-CL
3" Drop, Fits 7/8" Tubing	702-608-CL	3" Drop, Fits 7/8" Tubing	702-624-CL	3" Drop, Fits 7/8" Tubing	702-640-CL
3" Drop, Fits 1" Tubing	702-609-CL	3" Drop, Fits 1" Tubing	702-625-CL	3" Drop, Fits 1" Tubing	702-641-CL
Fixed, Quick Release	\$140.45	Fixed, Quick Release	\$140.45	Fixed, Quick Release	\$156.75
1" Drop, Fits 7/8" Tubing	702-602-CL	1" Drop, Fits 7/8" Tubing	702-618-CL	1" Drop, Fits 7/8" Tubing	702-634-CL
1" Drop, Fits 1" Tubing	702-603-CL	1" Drop, Fits 1" Tubing	702-619-CL	1" Drop, Fits 1" Tubing	702-635-CL
2" Drop, Fits 7/8" Tubing	702-606-CL	2" Drop, Fits 7/8" Tubing	702-622-CL	2" Drop, Fits 7/8" Tubing	702-638-CL
2" Drop, Fits 1" Tubing	702-607-CL	2" Drop, Fits 1" Tubing	702-623-CL	2" Drop, Fits 1" Tubing	702-639-CL
3" Drop, Fits 7/8" Tubing	702-610-CL	3" Drop, Fits 7/8" Tubing	702-626-CL	3" Drop, Fits 7/8" Tubing	702-642-CL
3" Drop, Fits 1" Tubing	702-611-CL	3" Drop, Fits 1" Tubing	702-627-CL	3" Drop, Fits 1" Tubing	702-643-CL
Adjustable, Standard Clamp	\$148.40	Adjustable, Standard Clamp	\$148.40	Adjustable, Standard Clamp	\$164.70
Fits 7/8" Tubing	702-612-CL	Fits 7/8" Tubing	702-628-CL	Fits 7/8" Tubing	702-644-CL
Fits 1" Tubing	702-613-CL	Fits 1" Tubing	702-629-CL	Fits 1" Tubing	702-645-CL
Adjustable, Quick Release	\$152.50	Adjustable, Quick Release	\$152.50	Adjustable, Quick Release	\$168.85
Fits 7/8" Tubing	702-614-CL	Fits 7/8" Tubing	702-630-CL	Fits 7/8" Tubing	702-646-CL
Fits 1" Tubing	702-615-CL	Fits 1" Tubing	702-631-CL	Fits 1" Tubing	702-647-CL

*Choose color and material from page 158

Seat Support Board

Fits Standard 18" adult chair. Special sizes and materials available upon request. Uses black, zinc plated stainless steel hardware.

When ordering specify: Proposed Make of Chair, Proposed Model of Chair, Width of Chair and Armstyle (Removable or Fixed Arms). Covering (black paint, wood stain, Naugahyde, Nylon or Mesh)



*Choose color and material from page 158

Drop Hooks, Standard Clamp	\$81.30	Adjustable, Standard Clamp	\$111.80
1" Drop, Fits 7/8" Tubing	702-500-CL	Fits 7/8" Tubing	702-516-CL
1" Drop, Fits 1" Tubing	702-503-CL	Fits 1" Tubing	702-517-CL
2" Drop, Fits 7/8" Tubing	702-501-CL	Adjustable, Quick Release	\$121.70
2" Drop, Fits 1" Tubing	702-504-CL	Fits 7/8" Tubing	702-518-CL
3" Drop, Fits 7/8" Tubing	702-502-CL	Fits 1" Tubing	702-519-CL
3" Drop, Fits 1" Tubing	702-505-CL		
Drop Hooks, Quick Release	\$91.30		
1" Drop, Fits 7/8" Tubing	702-510-CL		
1" Drop, Fits 1" Tubing	702-513-CL		
2" Drop, Fits 7/8" Tubing	702-511-CL		
2" Drop, Fits 1" Tubing	702-514-CL		
3" Drop, Fits 7/8" Tubing	702-512-CL		
3" Drop, Fits 1" Tubing	702-515-CL		



Swing-Away Trunk Support

Made with Naugahyde, nylon, or mesh, ½" foam and ½" wood. Attaches to drop hook or solid back. Black, anodized aluminum bracket with stainless steel components make it adjustable. Special sizes and materials available upon request. Easy locking spring loaded mechanism for smooth swing-away action. Sold in pairs.

Straight	\$220.80 a pair	1" Offset	\$235.75 a pair	2" Offset	\$235.75 a pair
Small (4"x5")	704-200-CL	Small (4"x5")	704-201-CL	Small (4"x5")	704-202-CL
Medium (5"x6")	704-203-CL	Medium (5"x6")	704-204-CL	Medium (5"x6")	704-205-CL
Large (6"x7")	704-206-CL	Large (6"x7")	704-207-CL	Large (6"x7")	704-208-CL

*Choose color and material from page 158



Fixed Trunk Support

Made with Naugahyde, nylon, or mesh, ½" foam and ½" wood. Attaches to either drop hook or solid backs. Black, anodized aluminum bracket makes it adjustable. Special sizes and materials available upon request. Sold in pairs.

Straight	\$60.00 a pair
Small (4"x5")	703-400-CL
Medium (5"x6")	703-403-CL
Large (6"x7")	703-406-CL
1" Offset	\$78.00 a pair
Small (4"x5")	703-401-CL
Medium (5"x6")	703-404-CL
Large (6"x7")	703-407-CL
2" Offset	\$78.00 a pair
Small (4"x5")	703-402-CL
Medium (5"x6")	703-405-CL
Large (6"x7")	703-408-CL

*Choose color and material from page 158



Clamp-On Trunk Support

Made with Naugahyde, nylon, or mesh, ½" foam and ½" wood. Attaches to 1" or 7/8" tubing. Black, anodized bracket makes it adjustable. Special material and sizes are available upon request. Sold in pairs.

Trunk Support	\$105.00 a pair
Small (4"x5")	703-421-CL
Medium (5"x6")	703-423-CL
Large (6"x7")	703-425-CL

*Choose color and material from page 158

Flip Down Abductor Pad and Bracket

Made with Naugahyde, nylon, or mesh, ½" closed cell foam and wood. Attaches to either drop hook or solid seats. Black, anodized aluminum bracket with stainless steel components make it adjustable.

Abductor Pad and Bracket \$91.26

- Small (5"x3"x4") **706-200-CL**
- Medium (6"x4"x5") **706-201-CL**
- Large (7"x4½"x5") **706-202-CL**

*Choose color and material from page 158



Hip and Thigh Support Pads

Made with Naugahyde, 1" foam and ½" wood with straps to attach to chair. Sold in pairs.

Support Pads \$48.75 a pair

- 15"x4½" **703-204-CL**

*Choose color and material from page 158



Fixed Hip and Thigh Supports

Made with Naugahyde, nylon, or mesh, ½" foam and ½" wood. Attaches to either a drop hook or solid seat. Black, anodized aluminum bracket makes it adjustable. Size: 16"x5" with specialty sizes available. Sold in pairs.

Hip and Thigh Support

- Straight **703-200-CL \$56.00 a pair**
- 1" Offset **703-201-CL \$60.00 a pair**
- 2" Offset **703-202-CL \$60.00 a pair**

*Choose color and material from page 158



Lateral Supports

Made with Naugahyde, 1" foam and ½" wood with 1" web and velcro straps to attach to chair. Specify left or right when sitting in chair. Custom sizes available upon request on all upholstered items.

Lateral Support 194-3CL-SD \$75.00

*Choose color and material from page 158



Stainless Steel Standard Drop Hook

Black, zinc plated stainless steel
Includes attaching hardware



Fits 7/8" Tubing	\$5.81
1" Drop	701-001
1½" Drop	701-004
2" Drop	701-002
2½" Drop	701-005
3" Drop	701-003

Fits 1" Tubing	\$5.81
1" Drop	701-009
1½" Drop	701-012
2" Drop	701-010
2½" Drop	701-013
3" Drop	701-011

Stainless Steel Adjustable Drop Hook

Black, zinc plated stainless steel
Includes attaching hardware



Drop Hook	\$12.75
Fits 7/8" Tubing	701-007
Fits 1" Tubing	701-008

Stainless Steel Standard Clamp

Black, zinc plated stainless steel



Standard Clamp	\$9.75
Fits 7/8" Tubing	702-001
Fits 1" Tubing	702-003



Stainless Steel Quick Release Clamp

Black, zinc plated stainless steel

Standard Clamp	\$16.00
Fits 7/8" Tubing	702-007
Fits 1" Tubing	702-008

Stainless Steel Fixed Clamp

Black, zinc plated stainless steel

Fits 7/8" or 1" Tubing	
702-002	\$5.81

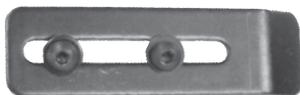

Aluminum Hip, Thigh and Trunk Support Bracket

Black, Anodized Aluminum

Brackets		
Straight	703-001	\$18.80
1" Offset	703-002	\$20.05
2" Offset	703-003	\$20.05



Aluminum Flip Down Abductor Bracket

Black, Anodized Aluminum
Bracket 706-001 \$74.45



Aluminum Swing-Away Trunk Support Bracket

Black, Anodized Aluminum

Bracket		
Straight	704-001	\$137.95 a pair
1" Offset	704-002	\$138.30 a pair
2" Offset	704-003	\$138.50 a pair

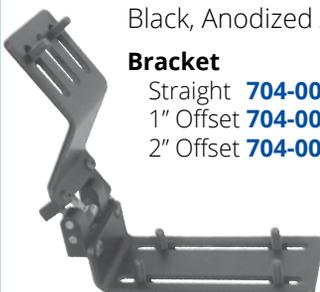

Clamp-On Trunk Support Bracket

Black, Anodized Aluminum

Fits 7/8" or 1" Tubing	
702-010	\$63.76



Aluminum Adjustable Head and Neck Support

Black, Anodized Aluminum
Bracket 705-004 \$68.75



Under Arm Crutches

Lighter than wood, the standard aluminum crutch provides stability and durability. Double extruded center tube provides additional strength to weight-bearing area. Push-pin adjustment makes it easy to adjust crutch height in 1" increments. Non-skid, jumbo size rubber tips provide excellent traction. Easy wing nut adjustments for hand grips. Comfortable, durable rubber underarm pad and hand grip.

Under Arm Crutch	\$18.50 a pair
Tall	241-500
Adult	241-501
Youth	241-503



Bariatric Under Arm Crutches

Large double push buttons allow for height adjustments in 1" increments. Crutch frame offers durable steel construction. Patient height guide on crutch for easy adjustment. Weight Capacity: 550 lbs.

Adult: Height Adjusts 44" to 52", User Height 5'2" to 5'11"
Tall: Height Adjusts 52" to 60", User Height 5'10" to 6'6"



Universal Aluminum Crutches

The Drive Medical universal height adjustment allows both children and adults to use this product (individuals 4'6" to 6'6"). Crutch disassembles for convenient storage. Euro-style clips and push pin adjustments make it easy to adjust the hand grip. Lighter than wood, the aluminum crutch provides stability and durability and non-skid, jumbo-size vinyl contoured tips provide excellent traction.

Universal Aluminum Crutches	\$27.95 a pair
241-519	



EuroStyle Lightweight Forearm Crutch

Vinyl coated, tapered contoured arm cuffs mold to user for maximum comfort and support.



EuroStyle Lightweight Crutches	
Blue	241-408 \$31.53 a pair
Silver	241-406 \$31.53 a pair

Utility Tips

These tips can be used on many different items such as Walkers, Canes, Crutches, Quads, Commodes and many other items.

Box of 4	Standard	Deluxe
Fits 1 1/8" Tubes	\$4.27 250-201	\$6.42 250-220
Fits 1" Tubes	\$3.75 250-202	\$5.48 250-221
Fits 7/8" Tubes	\$5.52 250-203	\$8.84 250-222
Fits 3/4" Tubes	\$4.00 250-204	\$6.84 250-223
Fits 5/8" Tubes	\$3.75 250-205	\$16.00 250-224
Fits 1/2" Tubes	\$3.75 250-206	\$8.84 250-225



Hand Grip

Hand Grip	
Closed	251-104 \$3.07 pr.
Split	251-105 \$4.33 pr.

Underarm Pad



251-103 \$4.68 pr.

Crutch Tip





Standard Canes

Many different styles of canes are available. We have displayed the most popular ones. If you are looking for something different please call and we will be happy to find what you need.

Cane

A. Adjustable, Offset Handle Cane	241-200	\$9.75
B. Adjustable, Standard Handle Cane	241-201	\$10.20
C. Adjustable, Folding Cane, Black	241-203-BK	\$19.63
D. Cane Seat, Weight Capacity: 250 lbs	241-103	\$26.67



Quad Cane

Features:

- › One button height adjustments
- › No assembly required
- › Weight Capacity: 300 lbs

Quad Cane

Small	241-101	\$13.95
Large	241-100	\$16.37



Heavy Duty Single Point Cane

Non-adjustable, fixed height, custom-made to customers specifications. Double-tubed from tip to tip for added strength. Foam grip handle. Weight Capacity: 700 lbs.

Note: Specify Height, measure from floor to top of hand grip.

Cane	241-801	\$78.57
------	----------------	----------------



Heavy Duty Quad Cane

Features:

- › Powder coated steel base
- › Push button adjustment
- › Vinyl comfort grip
- › Height: 29½" to 38½"
- › Weight Capacity: 700 lbs



Quad Cane

Small Base	241-813	\$29.95
Large Base	241-814	\$34.95

Replacement Cane Grips



Rubber Grip	\$9.06
7/8" Black	251-109



Cane Tripod

Replaces existing cane tip. Provides greater support, for right or left handed canes. Replacements for ¾" cane tips.

Cane Tripod	250-149	\$26.73
--------------------	----------------	----------------



Cane Ice Tip

Safer walking in ice or snow. Easy flip up design when not in use. Attaches easily on all canes and crutches.

5 Prong	250-136	\$6.92
----------------	----------------	---------------

Dual Pad Steerable Knee Walker with Basket

Specifications:

- › 8" casters are ideal for indoor/outdoor use
- › Deluxe dual braking system
- › Durable, steel frame with brown vein finish tool free height adjustment
- › Ideal for individuals recovering from foot surgery, breaks, sprains, amputation and ulcers of the foot
- › Knee walker can be steered for increased maneuverability
- › New, two-piece padded leg pad provides comfort
- › Removable front basket



Knee Walker with Basket 240-471 \$178.99

Pediatric Glider Walker

- › Aluminum frame
- › Comes with adjustable handles and legs that make this walker extremely versatile to accommodate virtually any physical requirements
- › Flat-free tires allow for both indoor and outdoor use
- › angled handle on pediatric model
- › Wide base provides additional stability



Pediatric Glider Walker 240-472 \$89.95 DISC.

UpRise Onyx Folding Walker

Combination of folding walker and rising aid all in one. The secondary handles provide stable assistance from a seated to a standing position. Attractive, upscale Onyx finish. Single release folding mechanism is designed to aid users with limited hand dexterity. Can be used as a portable toilet safety frame. Durable aluminum tubing provides strength while remaining lightweight. Adjustable height fits a broad range of user heights. Contoured, plastic grips for enhanced comfort and a secure hold. Designed to meet the requirements of HCPCS code: E0135.

Specifications:

- Width inside hand grips: 18"
- Width inside rear legs: 23"
- Overall Width: 26"
- Height Adjustment: 5'4" - 6'2"
- Weight Capacity: 400 lbs.



UpRise Walker 240-106 \$47.50

Side Walker

Designed for individuals with the use of only one hand or arm. Lighter than a walker and more stable than a cane. Height adjustment 29.5" to 34.5". Folds easily with one hand. Ideal for users who do not require a walker but need a wider base for support.

Side Walker 241-304 \$32.33



Pediatric Gait Trainer

The Trekker Gait Trainer can be used in the anterior and posterior position. The directional lever allows either forward and reverse mobility or only forward mobility, depending on the needs of the user. The variable resistance controls the speed of the rotation of the wheel, swivel casters can be locked to non-swivel, and the brakes lock as well to prevent the unit from moving. The height can be adjusted in 1" increments

Pediatric Gait Trainer 240-502-54 \$600.20





Dual Release Folding Walker

Easy to locate/use red button release can be operated by fingers, palm, or side of hand. Cross braces are located near hand grips to allow for full stride. Sturdy 1" diameter anodized, extruded aluminum tubing construction ensures maximum strength while remaining light-weight. Walkers with wheels include rear glide tips, allowing use on all surfaces.



Dual Release Folding Walker

Adult, No Wheels	240-122	\$29.95
Junior, No Wheels	240-123	\$31.13
Adult, with 3" Wheels	240-162	\$39.62
Junior, with 3" Wheels	240-163	\$25.95
Adult, with 5" Wheels	240-160	\$32.95
Junior, with 5" Wheels	240-161	\$33.47

Specification:

	Adult	Junior
Width (overall):	23" (25" with wheels)	23" (25" with wheels)
(inside hand grip):	17"	17"
(inside back leg):	20"	20"
Depth (opened at base):	18" (18½" with 5" Wheels)	18"
Height(highest setting):	39"	32" (34" with 5" wheels)
(lowest setting):	32"	25" (27" with 5" Wheels)
Weight Limit:	300 lbs	300 lbs



Single Release Folding Walker

Adult, No Wheels	240-115	\$37.08
Junior, No Wheels	240-116	\$33.95
Adult, with 5" Wheels	240-166	\$41.37

Single Release Folding Walker

Single-button release allows quick, one hand folding. Cross brace is located near hand grips to allow for full stride. Sturdy 1" diameter anodized, extruded aluminum tubing construction ensures maximum strength while remaining light-weight. Walkers with wheels include rear glide tips, allowing use on all surfaces.

Specification:

	Adult
Width (overall):	23" (25" with wheels)
(inside hand grip):	17"
(inside back leg):	21"
Depth (opened at base):	18½"
Height(highest setting):	32" to 39"
Weight Limit:	300 lbs



Deluxe, Dual Palm Release Folding Walker

Palm Release feature is ideal for individuals with limited finger dexterity. Palm release "pops-up" when the walker is open. Durable, composite palm release resists cracking and breaking. Sturdy 1" diameter anodized, extruded aluminum tubing construction ensures maximum strength while remaining light-weight.

Specification:	Adult	Junior
Width(overall):	27"	27"
(inside hand grip):	19"	19"
(inside back leg):	25"	25"
Depth(opened at base):	18"	18"
Height(highest setting):	39"	32"
(lowest setting):	32"	25"
Weight Limit:	300 lbs	300 lbs



Easy Release Folding Mechanism

Deluxe, Trigger Release Folding Walker with 5" Wheels

Features:

Trigger release feature for opening and closing allows users to close the walker without removing their hands from the handle and is ideal for individuals with limited finger dexterity. Trigger release can be reached with hands of all sizes.

Deluxe, Trigger Release Folding Walker with 5" Wheels
240-178-AD \$35.95



Dual Release Folding Walker with 5" Wheels and Tennis Ball Glides

Easy to locate/use button release can be operated by fingers, palm, or side of hand. Cross braces are located near hand grips to allow for full stride. Sturdy 1" diameter anodized, extruded aluminum tubing construction ensures maximum strength while remaining light-weight.



Specification:

Width (overall):	25"
(inside hand grip):	17"
(inside back leg):	20"
Depth (open at base):	18"
Height (highest setting):	39"
(lowest setting):	32"
Weight Limit:	350 lbs



Easy Release Folding Mechanism



Tennis Ball Glide Extension Replacement Pads for Tennis Ball Glides

250-213 \$14.95 pair
250-214 \$12.95 pkg

Walker Attachments

Walker Attachments fit Drive, Lumex and most walkers with 1" O.D. tubing

- A. 3" Walker Wheels
- B. 5" Wheels with Rear Glide Caps
- C. 3" Swivel Walker Wheels

- E. 5" Swivel Lock Walker Wheels
- F. 3" Rubber Wheels with Rear Glide Brakes
- G. Extension Legs
- H. 5" Wheels with Extension Legs



250-190 \$11.18 pair
250-189 \$12.58 pair
250-110 \$29.77 a pair

250-186 \$35.93 a pair
250-184 \$25.28 a pair
250-182 \$20.20 a set
250-183 \$32.68 a set

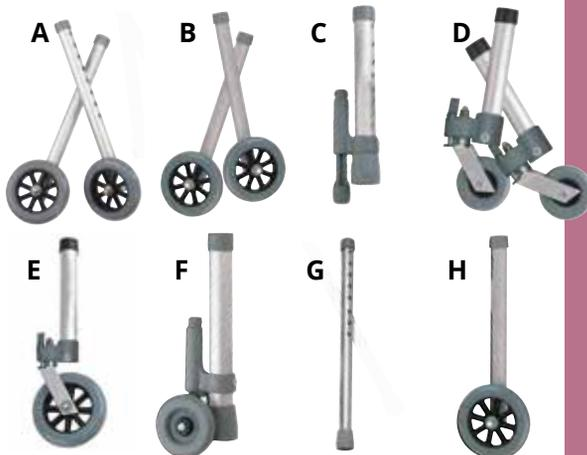

Glide Ski

Durable composite construction ensures long life. Allows walker to slide easily and smoothly over most surfaces. Replaces rubber tip.



Glide Ski 250-181 \$5.95 pair

Walker Tips

- > Provides stability to walker
- > Sold in sets of 4
- > Fit 1" O.D. Tubing



See page 76 for more sizes

Walker Tips 250-202 \$3.75 box

Glide Cover

Glide cover for use over existing rubber tip. Allows walker to glide across most surfaces.



Glide Cover 250-180 \$3.95 pair

Fashion Walker Tote Bags

- > Double sided with two pockets held in place with hook and loop
- > Easy to carry lighter items such as magazines, newspapers or wallet



Glide Cap

Allows walker to slide easily and smoothly over most surfaces. Replaces rubber tip.



Glide Cap 250-179 \$6.24 pair



Easy Care Folding Walker



Specifications:	Adult	Youth
Width:	16¼"	16¼"
Depth:	17"	16"
Height:	34" to 38"	29" to 33"
User Height:	5'4" to 6'2"	4'7" to 5'5"
Weight Capacity:	300 lbs.	300 lbs.

Folding Walker	\$50.73
Adult	240-153
Youth	240-154

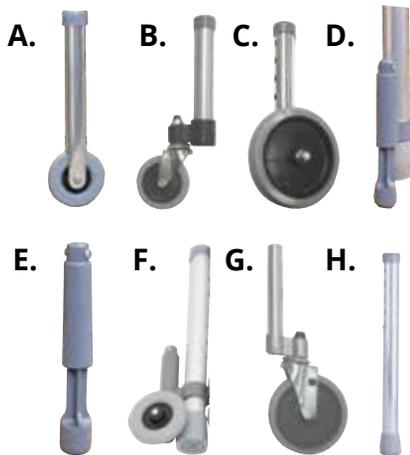

Walker Attachments



Walker Attachments (fits over 1" O.D. Tubing)

A. 3" Gray Rubber Wheel	250-102	\$27.12 a pair
B. 3" Gray Rubber Swivel Wheel	250-122	\$45.82 a pair
C. 5" Gray Rubber Wheel	250-100	\$25.62 a pair
D. Standard Leg with Glide Brake	250-106	\$31.68 a pair
F. 3" Gray Rubber Wheel with Brake	250-131	\$32.22 a pair
G. 5" Gray Rubber Swivel Wheel	250-148	\$49.22 a pair

Walker Extensions (extends the height adjustments by up to 7")

A. and H. Tall 3" Gray Rubber Wheel and Tall Leg Extensions	250-103	\$39.02 a set
C. and H. Tall 3" Gray Rubber Swivel Wheels and Tall Leg Extensions	250-101	\$47.52 a set
H. Tall Leg Extensions	250-105	\$25.42 a set



Dual Release Folding Walker



Specification:	Adult	Junior
Width:	17"	17"
Depth:	17½"	16½"
Height:	30" to 37"	25" to 32"
User Height:	5'3" to 6'4"	4'4" to 5'7"
Weight Capacity:	300 lbs.	300 lbs.

Folding Walker	
Adult	240-156 \$38.95
Junior	240-157 \$38.95

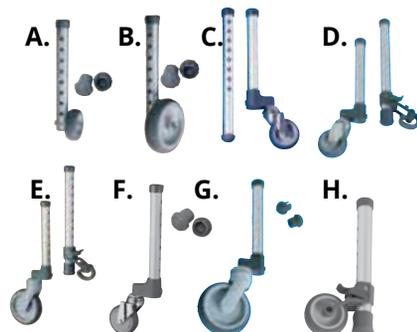

Walker Attachments



Walker Attachments

A. 3" Fixed Wheel with Rear Glide Tips	250-121	\$10.42 a pair
B. 5" Fixed Wheel with Rear Glide Tips	250-165	\$12.80 a pair
C. 3" Swivel Wheel with 13" Rear Leg Extensions and Glide Tips	250-173	\$39.17 a set
D. 3" Swivel Wheel with 13" Cambered SureGlide Brakes	250-171	\$46.67 a set
E. 5" Swivel Wheel with 13" Cambered SureGlide Brakes	250-169	\$55.42 a set
F. 3" Swivel Wheel with Rear Glide Tips	250-172	\$31.67 a pair
G. 5" Swivel Wheel with Rear Glide Tips	250-170	\$42.50 a pair
H. 10" Rear Wheel Brakes	250-176	\$24.17 a pair
H. 13" Rear Wheel Brakes	250-177	\$24.17 a pair

Oversized Aluminum Folding Walker, Two Button

Specification:	Adult	Junior
Width (overall):	28"	28"
(inside hand grip):	17"	20"
(inside back leg):	25"	25"
Depth (opened at base):	21"	20½"
Height(highest setting):	39"	32"
(lowest setting):	32"	25"
Weight Limit:	500 lbs	500 lbs



\$55.95

Folding Walker

Adult	240-114	\$60.62
Junior	240-173	\$62.64

Heavy Duty Folding Walker

Specifications:

Width:	19"
Depth:	16¼"
Height:	34" to 38"
User Height:	5'4" to 6'2"
Weight Capacity:	400 lbs.



Folding Walker

240-155 \$78.20

Bariatric Walkers

Specifications:

Short	
Height:	27" to 30"
Overall Width:	28" at bottom of legs (25" at top)
Width:	22" between tubes at top
Depth:	22" at tips (14½" at top)
Weight:	10 lbs.
Weight Capacity:	850 lbs.

Standard

Height:	33" to 36"
Overall Width:	28" at bottom of legs (25" at top)
Width:	22" between tubes at top
Depth:	21" at tips (14½" at top)
Weight:	11 lbs.
Weight Capacity:	850 lbs.

Tall

Height:	39" to 42"
Overall Width:	28½" at bottom of legs (25" at top)
Width:	22" between tubes at top
Depth:	22" at tips (14½" at top)
Weight:	12 lbs.
Weight Capacity:	850 lbs.

Bariatric Short Walker

240-801 \$133.57

Bariatric Standard Walker

240-800 \$136.84

Bariatric Tall Walker

240-802 \$164.47



Bariatric Short Walker



Bariatric Standard Walker



Bariatric Tall Walker

Close Out Sale! While Supply Lasts

Compact Ovation Rolling Walker



\$29.95

Compact

Features:

- › Folds like a wheelchair
- › Back strap for support while sitting
- › 8" Casters for easy rolling (6" on X-Small)
- › Pull to stop, push to lock braking system
- › Adjustable height handles
- › Nylon sling seat for added comfort



Specifications:

	Adult X-Small	Adult Small	Adult Std
Width (btwn. handles):	16"	16"	16"
Handle Height:	29½" to 31¼"	31¼" to 33¾"	33¾" to 36½"
Seat Height:	19½"	21¼"	24½"
Weight Capacity:	250 lbs.	250 lbs.	250 lbs.

Options

Basket	739206	\$10.00
Tote Bag	739946	\$16.58



\$29.95

Standard

Standard Ovation Rolling Walker

Specifications:

	Adult X-Small
Width (btwn. handles):	16¾"
Handle Height:	28½" to 31½"
Seat Height:	19¼"
Weight Capacity:	250 lbs.

Compact Ovation Walker

Adult X-Small **7103995** **\$29.95**



Silver

Drive Medical I-Walker Rollator

Lightweight Euro-Style Rollator weighs only 17 lbs. and folds/collapses sideways to a compact, easy to transport walker. The frame easily folds with one hand. Zippered storage bag is removable, but can stay on the frame when folded.

Features:

- › Attractive, Euro-Style Design
- › Brake Cable inside Frame - Added Safety
- › 7" Front Casters allows excellent steering
- › Adjustable Back Support
- › Handle Height Adjustable
- › Fold-Up Seat Is Durable and Comfortable
- › Cross Brace Design Gives Added Stability
- › Folding Frame - Storage And Portability
- › Lightweight (only 17 lbs.)
- › Comes With Removable Carry Pouch



Specifications:

Handle Height:	33¾" to 38¾"
Width:	25½"
Length:	27"
Seat Depth:	9¾"
Seat Width:	18"
Seat Height:	20"
Weight Limit:	300 lbs.



Red



Blue

Drive I-Walker Rollator

240-475-CL \$144.47

Competitive Edge Rollator

Features:

- › 7.5" non-marring casters are ideal for indoor and outdoor use
- › Comes with a basket to store personal items
- › Comes with durable, plastic seat
- › Durable steel frame
- › Easy to use deluxe loop locks. Lever allows for independent handle height and angle adjustment
- › Removable, hinged padded backrest can be folded up and down

Specifications:

Handle Height: 31" to 37"
Width: 23½"
Length: 25½"
Seat Depth: 8½"
Seat Width: 15"
Seat Height: 21"
Weight Limit: 300 lbs.



\$59.95

Competitive Edge Rollator

240-468-CL \$59.95



Aluminum Rollator with Padded Seat

Specifications:

Width: 24"
Length: 28"
Seat Depth: 14"
Seat Width: 14"
Seat Height: 22"
Handle Height: 35" to 39"
Available in Blue or Red



Aluminum Rollator

6" Wheels **240-438-CL \$59.95**
8" Wheels **240-437-CL \$79.95**

Steel Rollator with 6" Wheels

Features:

- › Seamless padded seat.
- › Zippered pouch under seat for added privacy and security of personal items.
- › Removable, hinged, padded backrest can be folded up or down.
- › 6" Black non-marring casters with soft grip tires are ideal for indoor and outdoor use.
- › Easy-to-use deluxe loop locks.
- › Brakes with serrated edges provide firm hold.

Specifications:

Handle Height: 32" to 37"
Width: 24½"
Length: 27½"
Seat Depth: 14"
Seat Width: 12"
Seat Height: 20"
Weight Limit: 300 lbs.



\$62.95

Steel Rollator with 6" Wheels

240-476-CL \$64.30

Go-Lite Bariatric Steel Rollator, 8" Casters

Features:

- › Loop Lock Brakes
- › 18" x 13" padded seat
- › Front mounting basket
- › Adjustable handle height
- › 8" casters

Specifications:

Handle Height: 34" to 39"
Width: 28"
Length: 29"
Weight Capacity: 400 lbs.
Blue or Red frame



Go-Lite Bariatric

240-433-CL \$126.95

Echo Line Ambulator

The Echo Line Ambulators are made with the same quality as the standard ambulators. They are made with less of the standard frills, to keep the cost lower.

Specifications:

Internal Width: 18"	Gate Height: 30½"
External Width: 22"	Total Height: 39"
Seat Height: 20½"	Capacity: 250 lbs
Arm Height: 25"	Shipped: UPS/RPS

Echo Line 242-509-CL \$146.38

Specify color from page 158



Adjustable Height Ambulators

Features:

Removable upholstered vinyl cushion. Easy-operate safety bar. Personal effects bag. Safety strap. Both seat and arms adjust simultaneously to 4 heights. UPS/RPS shipped. Reinforced deluxe twin wheel casters.

Pediatric, Weight Capacity 250 lbs.

14" Between Arms with 3" Twin Casters	242-445-CL	\$185.00
14" Between Arms with 3" Heavy Duty Casters, 300 lbs	242-445-CL-HD	\$229.74

Standard, Weight Capacity 250 lbs.

16" Between Arms with 3" Twin Casters	242-443-CL	\$188.95
18" Between Arms with 3" Twin Casters	242-441-CL	\$209.10
18" Between Arms with 3" Heavy Duty Casters, 300 lbs	242-441-CL-HD	\$269.21
18" Between Arms with 3" Twin Casters and Outriggers	242-454-CL	\$231.25
18" Between Arms with 3" HD Casters and Outriggers, 300 lbs	242-454-CL-HD	\$279.74

Wide, Weight Capacity 375 lbs.

21" Between Arms with 3" Heavy Duty Casters	242-472-CL	\$199.95
21" Between Arms with 4" Heavy Duty Casters	242-473-CL	\$202.53



Extra Wide, Weight Capacity 375 lbs.

24" Between Arms with 3" Heavy Duty Casters	242-474-CL	\$209.01
24" Between Arms with 4" Heavy Duty Casters	242-475-CL	\$217.32



Options

Clip on Tray for 18" Ambulator	242-452	\$65.00
Clip on Tray for 21" Ambulator	242-477	\$48.22
Clip on Tray for 24" Ambulator	242-478	\$48.22

Specify color from page 158

Combination Wheelchair/Walker

Features:

- › Allows user to self-propel or use as an ambulator
- › No rust all plastic rear wheels with rubber tread
- › Anti-tip design

Specifications:

Internal Width: 18"
 External Width: 27.5"
 Seat Height: 23.5"
 Total Height: 42"
 Total Length: 43"
 Weight Capacity 250 lbs

Wheelchair/Walker 18"



242-440-CL **\$348.75**
 Specify color from page 158



Merry Walker®

The second generation Merry Walker transcends the original unit in all respects, including a trimmer and stronger steel frame. Easy to set up. Folds for easy portability and storage. The Merry Walker is an innovative alternative for use in the rehabilitation process. It is FDA registered.

Features:

- › Twin wheel casters providing safety and easy movement
- › Wipeable, self-contained bacteria-proof seat
- › Swell latch, locking feature for closure of cross arm and back
- › Bottom weighted for better stability
- › Ambulation device for mobility and independence, Weight Capacity: 300 lbs



Folds To 12" Wide

Merry Walker

Extra Small, User Height 4'5" to 4'9"
 Small, User Height 4'10" to 5'2"
 Medium, User Height 5'3" to 5'7"
 Large, User Height 5'8" to 6'0"
 Extra Large, User Height 6'1" to 6'5"

\$695.00	20" Wide	22" Wide
	242-429	242-428
	242-435	242-430
	242-436	242-431
	242-437	242-432
	242-438	242-433

Merry Walker Accessories

Activity Tray	242-434	\$78.57
I.V. Pole	198-100	\$31.00
Oxygen Tank Holder	198-200	\$48.39
I.V. and Oxygen Tank Holder	198-300	\$47.40



Merry Walker® Traveler

Traveler is a reverse seated walker. Merry Traveler addresses this problem by providing a high seat behind the person as they walk. The seat height of the Merry Traveler is placed high so it is available for the person to just sit on, placed right under the buttocks of the person.

Features:

- › Folds for storage and transport, Side pouch for personal items
- › Bottom weighted - tip resistant
- › Base is only 20 inches wide
- › Four 2 inch casters, 2 locking and 2 non-locking
- › Sized by height - XS to XL, Weight Capacity 250 lbs.

Merry Walker

Extra Small, User Height 4'5" to 4'9" **242-480**
 Small, User Height 4'10" to 5'2" **242-481**
 Medium, User Height 5'3" to 5'7" **242-482**

Large, User Height 5'8" to 6'0" **242-483**
 Extra Large, User Height 6'1" to 6'5" **242-484**





Sneaker Walker Glides

The Drive Medical Sneaker Walker Glides is a stylish tennis shoe glides that personalizes your walker. It allows for the rubber tip on walkers to be replaced and allows walkers to glide easily and smoothly over most surfaces.

Sneaker Walker Glides 250-216 \$13.95 pr.

Glide Ski

Durable composite construction ensures long life. Allows walker to slide easily and smoothly over most surfaces. Replaces rubber tip. Fits walkers with 1" O.D. tubing.

Glide Ski 250-181 \$5.95 pr.

Glide Ski

One size adjusts to fit most walkers. Inserts easily into walker tubing. Stainless steel tightening bolt.

Glide Ski 250-139 \$12.50 pr.



Glide Caps

When used with front wheels, allow walkers to easily and quietly glide across most surfaces.

Glide caps

Lumex, 1⁹/₁₆" O.D., Black **250-156 \$3.95 pr.**
Guardian, 1¹/₂" O.D., White **250-157 \$2.95 pr.**



Glide Caps

Allows walker to slide easily and smoothly over most surfaces. Replaces rubber tip. Fits walkers with 1" O.D. tubing.

Glide Caps 250-179 \$6.24 pr.

Glide Tips

Fits walkers with 1" O.D. tubing.



Glide Tips

Sold Individual **250-226 \$2.68**
Carton of 24 **250-178 \$49.95**



Utility Tips

These tips can be used on many different items such as Walkers, Canes, Crutches, Quads, Commodes and many other items. Boxes of 4.

Box of 4

	Standard	Deluxe
Fits 1 1/8" Tubes	250-201 \$4.27	250-220 \$6.42
Fits 1" Tubes	250-202 \$3.75	250-221 \$5.48
Fits 7/8" Tubes	250-203 \$5.52	250-222 \$8.84
Fits 3/4" Tubes	250-204 \$4.00	250-223 \$6.84
Fits 5/8" Tubes	250-205 \$3.75	250-224 \$16.00
Fits 1/2" Tubes	250-206 \$3.75	250-225 \$8.84

Walker Forearm Attachment



Designed for those who are unable to grip the walker. Cradles forearm in soft vinyl padding for comfortable weight bearing. Universally adjustable. Adjustable straps holds arm in place.

Forearm Attachment

250-114 \$34.32



Universal Walker Tray w/ Cup Holder

Walker Tray 250-208 \$34.32

Walker Pouch



Clip-On Walker Basket

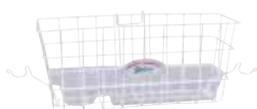

Walker Pouch 249-1CL \$17.80 Specify color from page 158
Walker Basket 249-212 \$16.20
Inserts 249-213 \$17.26

Flip Tray



Flip Tray 249-201 \$33.65

Walker Tray w/Cup Holders



Walker Tray 250-209 \$31.73



All Purpose Stool with Adjustable Arms

Kitchen stool features a padded seat and back for added comfort. Made with chrome plated steel for an attractive, durable finish. Comes with removable arm supports for added safety and comfort. Easily assembled and adjustable height to accommodate most size individuals.

Specifications:

Seat Height: 21" to 27" Seat Depth: 10½"
 Seat Width: 14" Weight Limit: 300 lbs.

All Purpose Stool **226-148** **\$49.95**



Hi-Design Hip Chair

Designed to benefit the patient with partial or total hip replacement, arthritis or knee surgery. Entry and exit from the chair is greatly eased by the increased seat height.

Specifications:

Floor to Seat Height: 27" Width Between Arms: 19"
 Arm Height: 31" Overall Width: 24"
 Footrest Height: 5½", 7½" and 9½" (adjustable) Weight Capacity: 300 lbs.

Hip Chair **280-400** **\$299.25**



for the road ahead
drive



Seat Assist

As you sit down on the Uplift Seat Assist, it eases you gently into a seated position. To get up, simply shift forward and begin to stand, the lifting piston activates automatically. This provides a gentle and stable lift up from the chair or sofa.

Specifications:

Base Depth: 16" Seat Width: 17"
 Base Width: 15" Weight: 9 lbs.
 Seat Depth: 19" Weight Range: 80 lbs. to 350 lbs.

Seat Assists

Standard with V-Foam, 80 lbs. to 230 lbs.
 Uplift Plus with V-Foam, 195 lbs. to 350 lbs.

Black Seat Cover

\$132.89
191-070
191-072
\$15.00
191-073-CL



Power Seat

- › To rise, pull up on the power lever, then place your hand(s) on the arm(s) of the chair or sofa while you are being lifted
- › The Uplift Power Seat will stop automatically when it reaches maximum height, or you can stop it by gently pushing down on the Power Lever
- › Now you can leave the armchair or sofa. The Uplift Power Seat is ready to help seat you when you return to your armchair or sofa

Specifications:

Base Depth: 17" Seat Width: 16"
 Base Width: 14" Weight: 12 lbs.
 Seat Depth: 19"

Power Seat Assist
Black Seat Cover

191-080 **\$136.18**
191-073-CL **\$15.00**



Echo Line Geri-Chair

The Echo Line Geri-Chairs are made with the same quality as the standard Geri-Chairs. They are made with less of the standard frills, to keep the cost lower.

Specifications:

Internal Width: 18"
External Width: 22"
Seat Depth: 22"
Weight Capacity: 250 lbs.



Echo Line 284-321-CL \$243.36

Specify color from page 158



PVC Multi-Position Geri-Chairs

Features:

- > 5-Position Adjustable back and legrest with extension
- > Safety push bar limits angle that back can recline
- > Anti-bacterial, urine, sulfide, oil mildew, and disinfectant resistant upholstered vinyl cushion
- > Retractable, self-storing footrest
- > 5"x1¼" extra wide casters
- > Available in Mauve, Wedgewood and White
- > 49" L x 24" W x 58.5" H
- > Seat height 26", 300 lb. capacity



21" Between Arms Width

Options: (Must be ordered with chairs)

Clip on Tray For 21" Chair

284-300-CL

\$296.25

284-905

\$65.00



Standard, 21" Seat Depth for 5'5" tall or over



Petite, 18" Seat Depth for 5'4" tall or under

PVC Multi-Position Geri-Chairs

Features:

- > Built-in wedge cushion, will increase safety and prevent risk patients from sliding forward
- > Solid base for better comfort, cushion will not sag or bottom out
- > Solid vinyl independent secured cushions, makes for easier cleaning and replacing
- > User friendly independent elevating and folding footrest
- > User friendly adjustable safety belt, is secured at all times to geri-chair frame
- > Push bar doubles as safety catch for reclining back
- > 5"x1¼" heavy-duty threaded stem casters for extra security and safety, casters will not fall/push out
- > NEW Bariatric chair available with a weight capacity of 700 lbs.



Specify color from page 158

18" Between Arms Width, Weight Capacity: 300 lbs.

18" Seat Depth with Elevating Legrest	284-301-CL	\$269.00
18" Seat Depth with Footrest and Elevating Legrest	284-302-CL	\$296.78
21" Seat Depth with Elevating Legrest	284-303-CL	\$277.93
21" Seat Depth with Footrest and Elevating Legrest	284-304-CL	\$294.29

21" Between Arms Width, Weight Capacity: 350 lbs.

18" Seat Depth with Elevating Legrest	284-305-CL	\$314.95
18" Seat Depth with Footrest and Elevating Legrest	284-306-CL	\$305.89
21" Seat Depth with Elevating Legrest	284-307-CL	\$290.66
21" Seat Depth with Footrest and Elevating Legrest	284-308-CL	\$316.13

24" Between Arms Width, Weight Capacity: 400 lbs.

18" Seat Depth with Elevating Legrest	284-309-CL	\$310.32
18" Seat Depth with Footrest and Elevating Legrest	284-310-CL	\$344.11
21" Seat Depth with Elevating Legrest	284-311-CL	\$315.03
21" Seat Depth with Footrest and Elevating Legrest	284-312-CL	\$337.57

30" Between Arms Width, Weight Capacity: 700 lbs.

23½" Seat Depth with Elevating Legrest	284-313-CL	\$530.53
23½" Seat Depth with Footrest and Elevating Legrest	284-314-CL	\$627.77

Options: (Must be ordered with chairs) Clip on Tray

For 18" Chair	284-907	\$25.49
For 21" Chair	284-908	\$41.77
For 24" Chair	284-909	\$66.37
For 30" Chair	284-913	\$73.47

Padded Lap Tray

For 18" Chair	284-914-CL	\$64.57
For 21" Chair	284-915-CL	\$75.38
For 24" Chair	284-916-CL	\$77.19
For 30" Chair	284-917-CL	\$113.76

Lap Security Bar

For 18" Chair	284-918	\$17.53
---------------	----------------	----------------

Double Drop Arms

284-912	\$50.85
----------------	----------------

18"



21"



24"



30"



3 Position Recliner



Features:

- › 3 Positions: upright, deep recline and elevated legrest/footrest
- › Self adjusting suspension in the seat prevents bottoming out
- › Large, blow molded tray can be stored on the side of the chair
- › Neutral colored, sturdy steel frame is easy to clean and maintain
- › Moisture barrier on seat prevents seepage
- › Foam and vinyl meet California Code #133 Flammability Standard and Boston Fire Department specifications.

\$339.00



Specifications - Standard:

Overall Height: 47"
 Overall Width: 25"
 Overall Depth: 41"
 Width (between arms): 20"
 Seat Height: 21"
 Seat Width: 19"
 Seat Depth: 19"
 Weight Capacity: 250 lbs

Specifications - Bariatric:

Overall Height: 47.5"
 Overall Width: 32"
 Overall Depth: 41.5"
 Width (between arms): 24.5"
 Seat Height: 21"
 Seat Width: 25"
 Seat Depth: 20"
 Weight Capacity: 500 lbs

Blueridge

Rosewood

Jade



3 Position

Blueridge
 Jade
 Rosewood

\$339.00

281-110
281-111
281-112



3-Position Recliner

Features:

- › Neutral isolate gray frame color
- › Three simple adjustment positions from upright to full recline are easily secured with the position lock bar
- › Durable 48-mil, high strength vinyl upholstery is easy to clean and maintain
- › Thick, low density soft foam provides maximum comfort
- › Overlap tray locks in a variety of positions and features a concave design to keep liquids on the tray
- › Two easy-roll 5" fixed front casters and two 5" total locking rear swivel casters provide easy maneuvering
- › Recliner mechanism is guarded for added safety
- › Full length arm pads with scuff guard protection
- › Removable overlap tray with easy one-button operation
- › Durable no-gap side panels are securely attached and won't snag clothing or skin



Specifications:

Height: 45½"
 Width: 24"
 Depth (upright): 43"
 Depth (reclined): 66"
 Seat Width: 18¾"

Seat Depth: 20"
 Seat-to-Back Height: 27"
 Seat-to-Floor Height: 18½"
 Tray: 23½"x18"
 Weight Capacity: 250 lbs.



3 Position Recliner

281-109-CL \$395.00

Horizon Blue Blueridge



Ortho-Biotic® Three Position Recliner Model 574G



LUMEX[®]
A Graham-Field Brand

New blow molded table can either slide on or off, or can be locked in one of five positions. The model 574G sets the industry standard for recliner design in long term care marketplace. Three easy to attain positions: sitting, elevated leg or full recline. Contoured seat back and articulating headrest maximizes individual comfort requirements. Flex-O-Lator seat virtually eliminates bottoming out. Welded heavy duty steel frame withstands long term use. Optional accessories include: winged headrest, side bolsters and I.V. pole attachment.

Specifications:

Overall Height:	47"	Arm Height (from seat):	9"
Overall Width:	25"	Seat Height:	21"
Overall Depth:	41"	Seat Width:	19"
Width (between arms):	20"	Seat Depth:	19"
Arm Height (from floor):	26"	Weight Capacity:	250 lbs.

3 Position Recliner

281-100-CL \$419.00

Specify color from bottom of the page when ordering



LUMEX[®]
A Graham-Field Brand



Clinical Recliner

Features:

- › Welded steel frame is made with round tubing for improved structural integrity
- › Softer seat and back, varied density seat back and redesigned seating position provides excellent comfort and support during long term sitting
- › Gas cylinder mechanism for quick Trendelenberg activation and improved lift
- › Durable side tables sit flush with chair arm to conveniently hold prep materials
- › Removable side panels for easy cleaning and maintenance
- › Multiple positions from: full upright to fully reclined
- › Tente swivel casters facilitate transport and maneuverability in confined areas
- › Limited Lifetime Warranty on welded frame, Limited One Year on upholstery and Limited Three Year on all other components

Specifications:

Overall Height:	47"	Seat Height:	22"
Overall Width:	31"	Seat Width:	21½"
Overall Depth:	35"	Seat Depth:	21"
Width (between arms):	22"	Depth fully reclined:	74"
Arm Height (from seat):	8"	Weight Capacity:	290 lbs.

Clinical Recliner **281-120-CL \$985.00**

Specify color when ordering



Blueridge

Doe Skin

Dove Gray

Gray Taupe



Jade

Pecan

Rosewood

Royal Blue

Terra Cotta



Preferred Care® Recliners

The unique mechanics, contemporary styling and variety of sizes make the 565 the choice for unparalleled comfort and support. Infinite recline back patented mechanism provides infinite positioning of the back ranging from 95°-145° for increased patient comfort and pressure relief. Chair can be locked into any number of positions. A unique suspension system self adjusts to each person, cradling the resident from head to heel and virtually eliminating the risk of bottoming out.

LUMEX[®]
 A Graham-Field Brand

Specifications:

	565WG:	565DG:	565TG:
Overall Height:	48"	48"	48"
Overall Width:	32"	28"	28"
Overall Depth:	37"	36"	36"
Width (between arms):	24"	19½"	19½"
Arm Height (from seat):	8½"	0" to 8½"	0" to 8½"
Seat Height:	20"	22"	22"
Seat Width:	24"	19"	19"
Seat Depth:	19½"	19½"	19½"
Weight Capacity:	400 lbs.	250 lbs.	250 lbs.



Care Recliner

- Extra Wide** Model 565WG
- Drop Arm** Model 565DG
- Tilt-In-Space** Model 565TG

281-106-CL	\$895.00
281-108-CL	\$685.00
281-107-CL	\$735.00

Accessories

Table Tray

for Standard, Drop Arm and Tilt-In-Space
 for Extra Wide

281-925	\$82.86
281-929	\$141.43

Head Bolster

For All

281-920-CL	\$76.67
-------------------	----------------

Body Bolster

For All (except Extra Wide)

281-921-CL	\$78.57
-------------------	----------------

Footrests

For All

281-922	\$82.86
----------------	----------------

I.V. Socket

For Standard, Petite and Extra Wide

281-924	\$33.33
----------------	----------------

Drainage Bag

For All

281-923-CL	\$40.63 DISC.
-------------------	----------------------



Winco 5670 XL Room Chair



Call For Available Colors

The new 5670 is an XL version of the 5580 room chair and adds all the benefits of the urethane arm chair with a wider seat and higher weight capacity. The XL version retains the beauty and practicality of the urethane arm chair yet accommodates larger patients with dignity and unmatched comfort. Suitable for patient rooms as companion chairs, in waiting areas, in the home environment or anywhere chair a higher style comfortable and durable chair is desired.

The Model 5670 is available with dual side tables and fixed feet in place of the casters. Standard black armrests are made of soft, durable urethane or choose from available armrest options in two different widths of beautiful contoured wood arms. The wood arms are available in warm shades of honey or walnut to complement the vinyl color or room decor as desired.

These Winco recliners feature the function, durability, cleanability and most of all the unmatched comfort you have come to expect from Winco in a beautiful look and design you'll be proud to place anywhere, including your living room.

Winco 5670 XL Room Chair **284-158-CL** **\$1,159.00**

Winco 6704 Room Chair



Call For Available Colors

Our most popular and stylish recliners in a fixed foot version suitable for patient rooms as companion chairs, in waiting areas, in the home environment or anywhere chair mobility is not needed.

The Model 6704 is identical to the 6700 clinical line featuring Trendelenburg capability and dual side tables with attractive fixed feet in place of the casters. Black armrests are soft, durable urethane or choose from available armrest options in two different widths of beautiful contoured wood arms. The wood arms are available in two warm shades of honey or walnut to complement the vinyl or room decor as desired.

These Winco recliners feature the function, durability, cleanability and most of all the unmatched comfort you have come to expect from Winco in a beautiful look and design you'll be proud to place anywhere, including your living room.

Winco 6704 Room Chair **284-156-CL** **\$1,014.00**

Rock King Wheelchair X3000



Rocking

285-500-CL

Features:

Upright Position

Ideal for seating at dining and activity tables.

Adjustability

Ergonomic design supports head, shoulders, lower back: adjustable seat provides leg comfort, aids self-propulsion.

Comfort

Crypton padded seat is designed for extended sitting and effortless cleaning. Reversible cushion for your personal preference.

Safety

Greater stability and support can reduce or eliminate the need for protective restraints.

Rocking

A simple flip of a lever turns the unique wheelchair into a rocking chair.

Quick Angle Adjustment

Allows proper positioning and spring tension.

Arm Clearance

Prevents bumping elbows during self-propulsion.

Tilt Position

Great for napping, reading and conversation; also prevents pressure ulcers.

Side Supports

Height adjustable support to prevent slouching.

Specifications:

Seat Height from Floor
(Adjustable in 1-inch increments): 19" in.
Overall Width: 28.5" in.
Chair Weight (no accessories) 63 lb.

Overall Length (without footrests): 32" in.
Seat Width: 20" in.
Seat Depth: 16" in.
Height of Backrest from Seat: 32" in.
Weight Capacity: 350 lbs.

Rocking Wheelchair X3000 **285-500-CL** **\$223.95**



SHIPS BY TRUCK



Optional Accessories:

Lateral Supports	285-555-CL	\$221.05
Elevating Leg Rests	285-554	\$366.58
Footrests, Vertical Adjustment	285-572	\$215.53
Heel / Leg Strap Velcro Attachment (black)	285-557	\$36.67
Comfy Heel / Leg Strap	285-558	\$58.33
Reversible Crypton Cushion	285-550-CL	\$233.95
Reversible: Floral/Port or Blue		
Reversible: Crypton Cushion Velcro Closure	285-551-CL	\$190.78
Crypton Fabric Standard Head Pillow	285-552-CL	\$90.00
Crypton Fabric Support Head Pillow	285-553-CL	\$128.00
Fabric Safety Strap	285-559	\$35.00
Padded Tray HD with Cup Holder	285-569	\$148.68
Padded Tray HD without Cup Holder	285-570	\$121.43
Oxygen Tank Holder	285-565	\$67.67
Body Bolsters, Crypton or Fleece, 2" or 3"	285-571-CL	\$95.00
Telescopic I.V. Pole	285-564	\$198.00
Crypton Catheter Bag Holder	285-562-CL	\$58.33
Crypton Elevated Leg Rest Joint Pad	285-563	\$43.33
Foot Rest Extender	285-566	\$104.28
Rigid Padded Calf Protector	285-568	\$208.16
Foot Cradle	285-567	\$445.06



285-553-CL



285-558



285-556-CL



285-569



285-570



285-552-CL



285-572



285-568



285-567



285-554



285-565



285-562-CL



285-564

285-566



Port



Blue



Reverse Side

285-550-CL



285-571-CL



285-559



SHIPS BY TRUCK

Manual Bed

Bed	200-598	\$359.00
W/Full Rails	200-606	\$379.00
W/Half Rails	200-607	\$379.00
W/Full Rails and Mattress	200-608	\$469.00

Multi-Height Manual Bed

Features:

- › Fully adjustable by operating the hand cranks at the foot of the bed.
- › Hand crank handles fold down to be concealed and prevent injury
- › Side clips under angle iron store shaft when bed is unassembled
- › Back and foot adjustment allow anatomically correct sleep surface
- › Channel frame construction provides superior strength and reduced weight
- › Zinc coated spring deck
- › Heavy-Duty, vinyl clad bed ends are attractive in any décor and easy to maintain
- › CSA approved
- › When ordered with mattress, comes with 80" Inner Spring Mattress Package



SHIPS BY TRUCK

Semi-Electric

Bed	200-573	\$511.57
W/Full Rails	200-609	\$539.00
W/Half Rails	200-610	\$539.00
W/Full Rails and Mattress	200-611	\$629.00

Semi-Electric Bed

Features:

- › Quiet, smooth operation
- › Side clips under angle iron store shaft when bed is unassembled
- › Back and foot adjustment allow anatomically correct sleep surface
- › Channel frame construction provides superior strength and reduced weight
- › Zinc coated spring deck
- › Heavy Duty, vinyl clad bed ends are attractive in any décor and easy to maintain
- › Head and foot ends are interchangeable with Invacare®
- › When ordered with mattress, comes with 80" Inner Spring Mattress Package
- › CSA approved



SHIPS BY TRUCK

Full Electric

Bed	200-577	\$569.00
W/Full Rails	200-612	\$654.00

Full-Electric Bed

Features:

- › Quiet, smooth operation
- › The easy-to-use hand pendant electrically controls the positioning of the upper body, knees, and overall height of the bed frame to provide maximum comfort and versatility for the patient or caregiver
- › Side clips under angle iron store shaft when bed is unassembled
- › Back and foot adjustment allow anatomically correct sleep surface
- › Channel frame provides superior strength and reduced weight
- › Zinc coated spring deck
- › Heavy-Duty, vinyl clad bed ends are attractive in any décor and easy to maintain
- › Head and foot ends are interchangeable with Invacare®
- › CSA approved

More beds and bed options available online at www.ocelco.com

Manual Bed Package

Manual cranks raise and lower upper body and knees as well as bed height.

Features:

- › Package includes: Bed, Bed Rails and 80" Deluxe Mattress
- › Reinforced Headspring for increased strength and comfort
- › 3" Tente casters with secure locking for greater mobility and unsurpassed quality

Manual Packages

		1-5	6+
W/Spring Loaded Full Rails	200-111	\$617.93	\$587.03
W/Half Rails	200-112	\$620.19	\$589.18

Individual Items

Manual Crank Hi/Lo Bed	200-010	\$470.17
Spring Loaded Full Bed Rails	201-105	\$80.57 a pair
Half Length Bed Rails	201-201	\$67.95 a pair
80" Deluxe Mattress	200-918	\$211.20



201-105



201-201

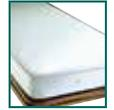

200-918



SHIPS BY TRUCK

Beds and 80" Deluxe Mattresses must ship by truck.

Semi-Electric Bed Package

Pendant control raises and lowers the upper body and/or knees. Manual crank adjusts bed frame height for caregiver assistance.

Features:

- › Bed packages includes: Bed, Bed Rails and 80" Deluxe Mattress
- › Reinforced Headspring for increased strength and comfort
- › 3" Tente casters with secure locking for greater mobility and unsurpassed quality

Semi-Electric Packages

		1-5	6+
W/Spring Loaded Full Rails	200-121	\$748.40	\$710.98
W/Half Rails	200-124	\$751.86	\$714.27

Individual Items

Semi-Electric Bed	200-020	\$575.74
Spring Loaded Full Bed Rails	201-105	\$80.57 a pair
Half Length Bed Rails	201-201	\$67.95 a pair
80" Deluxe Mattress	200-918	\$211.20

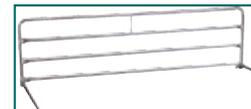

201-105



201-201

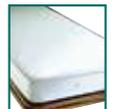

200-918



SHIPS BY TRUCK

Beds and 80" Deluxe Mattresses must ship by truck.

Full Electric Bed Package

All positions are controlled electrically to provide greatest convenience for the patient and ease to the caregiver. The hand pendant controls the positioning, of the upper body and/or knees, and can be placed anywhere for maximum patient comfort.

Features:

- › Bed packages includes: Bed, Bed Rails and 80" Deluxe Mattress
- › Reinforced Headspring for increased strength and comfort
- › 3" Tente casters with secure locking for greater mobility and unsurpassed quality

Full Electric Packages

		1-5	6+
W/Spring Loaded Full Rails	200-131	\$869.38	\$825.91
W/Half Rails	200-132	\$872.85	\$829.21

Individual Item

Full Electric Bed	200-030	\$694.36
Spring Loaded Full Bed Rails	201-105	\$80.57 a pair
Half Length Bed Rails	201-201	\$67.95 a pair
80" Deluxe Mattress	200-918	\$211.20

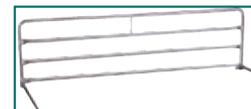

201-105



201-201



200-918



SHIPS BY TRUCK

Beds and 80" Deluxe Mattresses must ship by truck.

Low PVC Resident Beds

Features:

- › Frame is reinforced with aluminum inside PVC to eliminate cracking and breaking
- › 76" or 80" long; 36" wide internally (fits standard mattress)
- › Clearance from floor to bottom of frame 6"
- › 5 position reclinable models
- › 300 lb capacity
- › Pads (69" Long x 32" Wide x 2" Thick) attached to bed frame and folded out to cushion fall
- › 8 legs
- › Strapping on bed frame provides additional strength
- › Mattress not included



PVC Low Beds with High Impact Flat PVC Support Deck

Standard 76"x36"	200-105	\$150.65
Standard 80"x36"	200-106	\$150.65
Reclining/Elevating Head Section 76"x36"	200-107	\$262.50
Reclining/Elevating Head Section 80"x36"	200-108	\$262.50

Options: (Must be ordered with beds)

3" Threaded Stem Casters

Heavy Duty (4 locking and 4 non-locking)	200-113	\$50.00 a set
--	----------------	----------------------

Head and Footboards

Standard Mesh	200-109-CL	\$38.00
Solid Vinyl or Staph Chek	200-110-CL	\$46.67

All Purpose Mat

2'x4'x2"	200-203-CL	\$63.03
4'x4'x2"	200-204-CL	\$85.21
2'x5'x2"	200-205-CL	\$82.07
2'x6'x2"	200-207-CL	\$72.13

Safety Pad with Anti-Bacterial Protection

Specify color from page 158	200-114-CL	\$115.36
-----------------------------	-------------------	-----------------

Replacement 3" Heavy-Duty Casters

Threaded (4 locking and 4 non-locking)	200-113	\$50.00 a set
---	----------------	----------------------



Reclining/Elevating Bed with optional Head and Footboards, and Safety Pad



Econo-Wave™ Pillow

A popular foam pillow that gives you support at an economical price. Econo-Wave is a cervical pillow with a waved, or rippled surface. The waves provide even support and allows air to circulate while soothing your neck. The variable lobe sizes allow your neck to rest comfortably in its natural position.

Pillow

22"x16" Econo-Wave	202-920	\$38.88
Pillowcase (blue cloud)	202-912	\$11.37



Memory Plus Pillow™

Finally, a memory pillow that promotes proper sleeping posture. Giving you a soothing customized fit, the memory foam top conforms to your head. The resilient foam base provides full support, offering therapeutic value not found in other memory foam pillows. Covered with an attractive blue pillowcase.

Pillow

18"x13" Memory Plus	202-933	\$50.22
---------------------	----------------	----------------

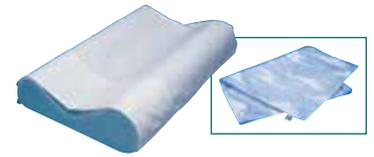

Basic Cervical Pillow™

You'll wake up refreshed when you sleep on this pillow. The pillow has two different support lobes; choose the size that's comfortable for you. Features a smooth surface, standard support.

Pillow

22"x16" Basic (firm)	202-918	\$25.22
22"x16" Gentle (soft)	202-919	\$25.22
Pillowcase (blue cloud)	202-912	\$11.37

Innerspring Mattress

Features:

- › Firm support for use in home care, nursing homes and hospitals where firm support is needed
- › High quality .312 Bonnell® innerspring design
- › Durable 11oz vinyl cover is anti-bacterial, anti-static, acid-resistant, and waterproof
- › Equipped with two screened brass vents
- › Conforms to California technical bulletin #117 for fire retardancy
- › Weight Capacity: 250 lbs.

Mattress

36"x80"x6"

200-918 \$211.20



Low Bed

Features:

- › Specially designed for Alzheimer residents or others with similar special needs
- › Ultra low, only 7" off the floor height for patient's safety
- › Welded angle steel construction with reinforced corner plates provide maximum stability
- › Reinforced head and foot spring provides maximum bed strength and support
- › Two piece split-spring design is easy to use, set up and operate
- › 3" swivel, locking casters provide increased security
- › Weight Capacity: 460 lbs.

80" Tuffcare Low Bed

with Head and Footboards

200-191 \$392.11 DISC.



SHIPS BY TRUCK

Tuffcare
 HIGHER STANDARD FOR HEALTH CARE™

The Zenith

Features:

- › Full electric with three DC ultra-whisper rapid-moving motors.
- › Height is adjustable from 8" to 30"
- › Weight capacity is 450 lbs
- › 15 Year unlimited warranty (except electronics and motors)
- › Ability to lock or move bed in all height positions

Zenith



SHIPS BY TRUCK



Shown with optional half rails
 and optional head & footboard.



Full Electric Bariatric Bed

Features:

- › Includes head and foot boards
- › Quiet, smooth operation
- › Heavy Duty Frame ensures strength and patient safety
- › All steel construction
- › Larger sleeping surface than conventional bed
- › No tools necessary for set-up
- › Hand control provides for multiple bed positioning for patients
- › Emergency manual crank included
- › Weight Capacity: 600 lbs.

Full Electric Bariatric Bed

Bed	200-581	\$795.00
with/1 pair T-Rails	200-582	\$875.00
with/1 pair T-Rails and Mattress	200-584	\$1,159.00



Century T5000

Features:

- › Welded rectangle steel tubing construction provides maximum stability
- › Two piece split frame design is easy to use, set up and operate
- › Heavy-Duty 6" swivel, locking casters provide increased security
- › Trendelenberg, reverse trend position can be easily achieved
- › UL approved electronic system provides quiet and smooth operation
- › Weight Capacity: 800 lbs. to 1,000 lbs.

T5000 with Foam Mattress and Half Bedrails

48"x80" Weight Capacity 800 lbs.	200-135	\$3,898.81 a PKG
54"x80" Weight Capacity 1,000 lbs.	200-136	\$3,976.19 a PKG
60"x80" Weight Capacity 1,000 lbs.	200-137	\$4,083.33 a PKG



Long Term Care Beds

Available in manual, semi-electric and full electric models. Options include pan or spring deck, Light Oak, Medium Oak or Walnut head and footboards. Does not include bedrails.

80" Beds

Manual, Spring Deck	200-174	\$434.57
Manual, Pan Deck	200-175	\$533.33



**Replacement Hand Controls and Junction Boxes fit almost any brand of bed.
 1 Year Warranty on all Hand Controls and Junction Boxes**

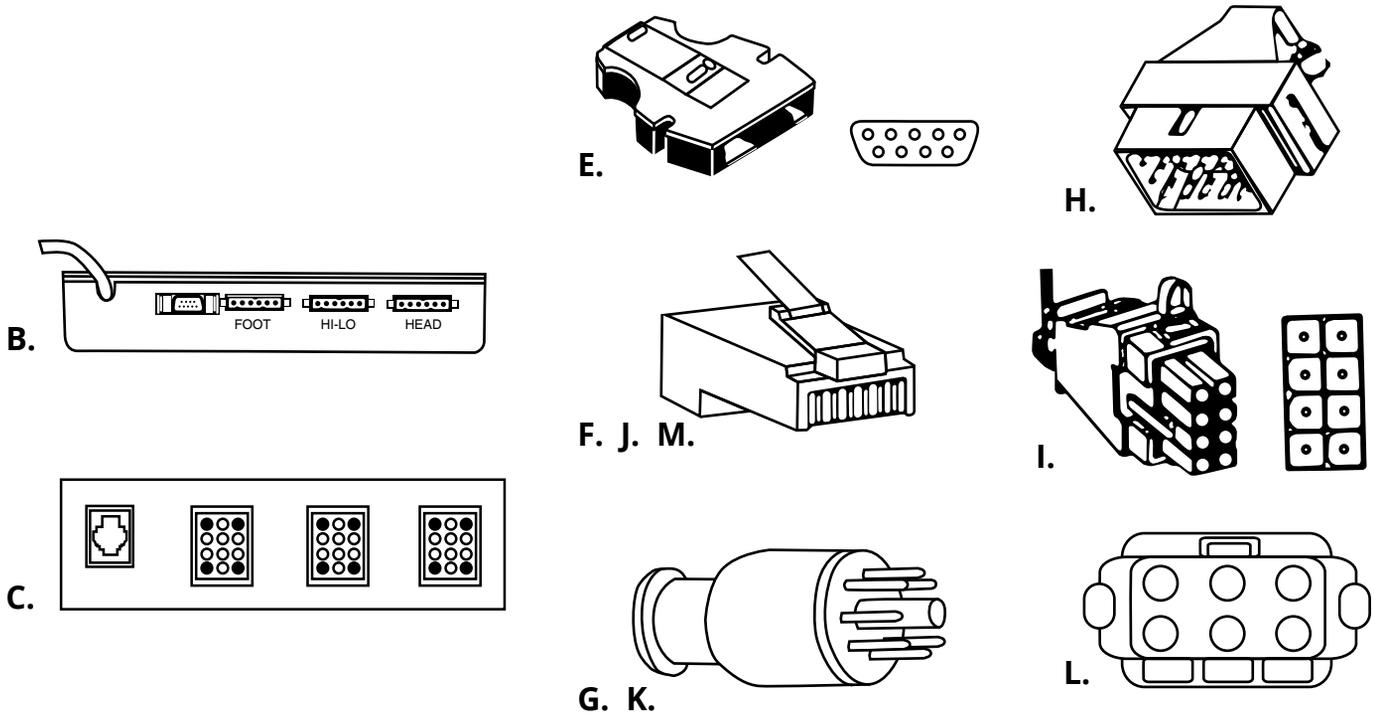

Junction Box

- B. Invacare, 6 function, older style semi electric before 7/98
- Invacare, 6 function, older style full electric before 7/98

Hand Control

- E. Invacare, 6 function, low voltage 9 pin computer connector
- Invacare, 4 function, low voltage 9 pin computer connector
- F. Smith & Davis, 6 function, low voltage 6 pin telephone connector
- Smith & Davis, 4 function, low voltage 6 pin telephone connector
- G. Smith & Davis and Invacare, 6 function, high voltage 8 pin connector
- Smith & Davis and Invacare, 4 function, high voltage 8 pin connector
- H. Sun-Tech and Joerns, 6 function, low voltage 15 pin connector
- Sun-Tech and Joerns, 4 function, low voltage 15 pin connector
- I. Sun-Tech and Joerns, 6 function, low voltage 8 pin connector
- Sun-Tech and Joerns, 4 function, low voltage 8 pin connector
- J. Sun-Tech and Joerns, 6 function, low voltage 8 pin telephone connector
- Sun-Tech and Joerns, 4 function, low voltage 8 pin telephone connector
- K. Sci-o-Tech, 6 function, high voltage 8 pin connector
- M. Sci-o-Tech and Lumex, 6 function, low voltage 8 pin telephone connector
- Sci-o-Tech and Lumex, 4 function, low voltage 8 pin telephone connector

200-404-SE \$371.64
200-404-FE \$419.40

200-402 \$104.03
200-403 \$100.81
200-407 \$104.03
200-408 \$102.29
200-409 \$137.10
200-410 \$158.87
200-411 \$104.03
200-412 \$100.81
200-413 \$104.03
200-414 \$100.81
200-415 \$104.03
200-416 \$100.81
200-418 \$166.41
200-421 \$99.19
200-422 \$95.97

Single and Dual Nurse Call Cords

The pendant is internally reinforced with a metal casing to avoid easy damage. All cords are supplied with a non removable, stainless steel bed sheet clip. The cord is compatible with all momentary systems having normally open contacts and a 2 conductor, ¼" phone plug.

Replaces: Altec, Auth, Callcare, Crest Cornell, Dukane, Executone, Jeron, Mastercom, Med-Tek, Picker-Briggs, Rauland, Tektone

Call Cords

Single, 6 Feet Long	316-100	\$12.43	Dual, 8 Feet Long	316-103	\$23.68
Single, 8 Feet Long	316-101	\$11.65	Dual, 10 Feet Long	316-105	\$21.65
Single, 10 Feet Long	316-102	\$14.33	Dual, 12 Feet Long	316-108	\$33.68
Single, 12 Feet Long	316-107	\$23.68			



Single and Dual Geriatric Nurse Call Cords

The pressure-sensitive pad allows the patient to call for assistance by lightly pressing on the pad. All cords are supplied with a non removable, stainless steel bed sheet clip. The cord is compatible with all momentary systems having normally open contacts and a 2 conductor, ¼" phone plug.

Replaces: Altec, Auth, Callcare, Crest Cornell, Dukane, Executone, Jeron, Mastercom, Med-Tek, Picker-Briggs, Rauland, Tektone

Call Cords

Single, 10 Feet Long	316-104	\$37.43
Dual, 10 Feet Long	316-106	\$74.93

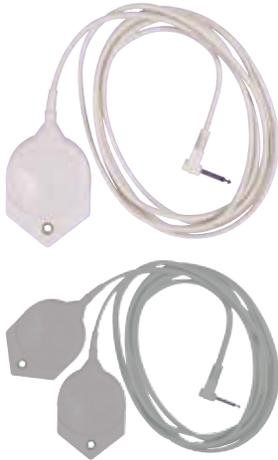

Security Clips



Metal clip attached to nylon strap. Tighten strap around nurse call cord and clip to bed linens. Keeps call button or pillow speaker near patient. No teeth to tear linens.

Clip 210-100 \$3.11



Hooks onto call cord and attaches to bed linens. Keeps call button or pillow speaker near patient. No teeth to tear linens. Large size for 5-conductor cords; small size for 2-conductor cords.

Clips

Small	210-102	\$2.69
Large	210-101	\$2.93



Twin security clip for use in holding feeding bibs, garments and linens. Overall length is 6½"

Clip 210-104 \$7.50



Clip only. Mounts with screw.
Clip 210-105 \$2.11



Nylon strap snaps around call cord. Clip end grips to bed linens to keep pillow speaker or call button in place.

Clip 210-106 \$2.82



Clips call cords to sheet. Velcro strip holds one or more cords or tubes. Washable.

Clip 210-107 \$3.00



Only \$15.95



	Reg. Price	Sale
Ocelco Pull String Monitor	305-461 \$19.14	\$15.95
Shock Absorber for Ocelco Alarms	305-462 \$7.98	\$6.65

For more Alarms and options see pages 112-117

Transfer Belt

These belts provide a secure method of assisting clients during gait training and transfer activities. Belt has a 2" metal buckle and made of heavy-duty cotton webbing.

Transfer Belts

48" long	305-130	\$8.25
54" long	305-140	\$8.70
60" long	305-150	\$9.15
72" long	305-160	\$9.60



Deluxe Wheelchair Transfer Board

Features:

- › Transfers easily from wheelchair, bed, chair, or toilet
- › Cut out handle for easy carrying
- › Made of urethane sealed; coated and polished hardwood
- › Weight Capacity: 400 lbs.



Features:

- › Unique design for easy transfer
- › Lightweight and easy to handle
- › Made of heavy-duty white plastic
- › Weight Capacity: 500 lbs.



Features:

- › Transfers from wheelchair to bed, car seat, bath board, etc.
- › Made of multi-laminated birch plywood with a smooth lacquer finish
- › Ends are tapered and edges are rounded for easily sliding on and off
- › Weight Capacity: 500 lbs. and 700 lbs.



Transfer Boards

8"x30" Wood with Handle	199-100	\$32.25
8"x27½" Plastic	199-101	\$16.28
9"x29" Wood	199-113	\$78.95
12"x29" Wood	199-114	\$82.24

Beasy Trans

Specifications:

Length:	40" ETS	27½" Beasy II	32" Beasy Glyder
Width:	12" seat		10" seat
Thickness:	1" base	½" seat	
Weight Capacity:	400 lbs.	400 lbs.	400 lbs.
Seat Rotation:	360°	360°	360°

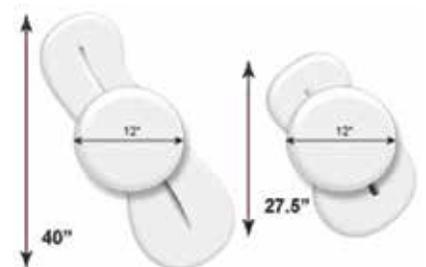

Beasy Trans

27½" Beasy II	199-108	\$209.21
32" Beasy Glyder	199-119	\$215.79
40" ETS	199-107	\$222.37
Carrying Case	199-120-SZ	\$33.25

32" Beasy Glyder





Mattress

- 36"x76"x6" **200-812** **\$129.00**
- 36"x80"x6" **200-813** **\$97.00**
- 36"x84"x6" **200-814** **\$117.00**

Spring-Ease™ Mattress

Features:

- › Extra firm support for use in home care and hospitals where extra firm support is needed
- › The innerspring is a Sureflex™ Bonnell .312 coil spring unit designed to catch in all positions of a hospital bed
- › The insulator pad is a heavy duty resonated pad with a specialized mesh woven back for added firmness and support
- › The units are multi-layered with 1.250" high density, firm, combustion modified foam toppers
- › The cover fabric is blue Masongard™ with weight of 10 oz.
- › The Spring-Ease™ unit is equipped with four evacuation handles and four screened brass vents
- › Conforms to California technical bulletin #117 for fire retardancy
- › Weight Capacity: 225 lbs.



SHIPS BY TRUCK

Mattress

- 36"x80"x6" **200-816** **\$141.36**

Ortho-Coil™ Mattress

Features:

- › Super firm support, tailored to the needs of the larger person
- › The innerspring is a Sureflex™ Bonnell .312, 123/4 gauge coil spring unit designed to catch in all positions of a hospital bed
- › The units have a center booster panel for orthopedic body support
- › The units have multi-layered comfort levels featuring a .5" high compression foam with a 1.25" high density firm combustion modified foam toppers
- › The cover fabric is green Masongard™ with weight of 12 oz.
- › The Ortho-Coil™ unit is equipped with four evacuation handles and four screened brass vents
- › Conforms to California technical bulletin #117 for fire retardancy
- › Weight Capacity: 300 lbs.



Mattress

- 36"x80"x6" **200-918** **\$211.20**

Innerspring Mattress

Features:

- › Firm support for use in home care, nursing homes and hospitals where firm support is needed
- › High quality .312 Bonnell® innerspring design
- › Durable 11oz vinyl cover is anti-bacterial, anti-static, acid-resistant, and waterproof for easy use and care
- › Equipped with two screened brass vents
- › Conforms to California technical bulletin #117 for fire retardancy
- › Weight Capacity: 250 lbs.



Plastic Mattress Covers

Heavy-gauge plastic provides protection from moisture, stains, and dust.

Contoured Covers

- 36"x76"x6" **200-863** **\$4.38**
- 36"x80"x6" **200-864** **\$3.60**

Zippered Covers

- 36"x76"x6" **200-860** **\$6.08**
- 36"x80"x6" **200-861** **\$5.33**
- 54"x76"x6" **200-862** **\$10.32**

Multi-Ply™ Variable Density Sleep System

Mason's Multi-Ply™ Series offers therapeutic support through a variable density sleeping surface that assists in the prevention and treatment of pressure sores. Each mattress in our series provides low interface pressure and greater air circulation through its specially designed foam core, while comfortably supporting the patient. All mattresses are engineered to provide years of trouble free use.

ShearCare 500 Select

This three zoned mattress is comprised of 670 individual cells that are independent from one another. This design allows the mattress to conform to the patient's contour & customize support as the patient moves. Superior pressure reduction is achieved by varying cell depths throughout the mattress zones.

ShearCare 500

36"x84"x5³/₄"

200-832 \$205.55

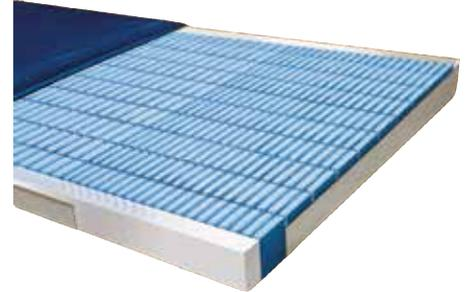

ShearCare 700 Premium

Three pressure relieving zones with a specifically designed top layer of precision cut, flat-top high density foam. The ShearCare 700 increases air circulation throughout the mattress system, reducing heat build-up between the patient and sleeping surface. Mattress is fully reversible end-to-end, increasing product longevity.

ShearCare 700

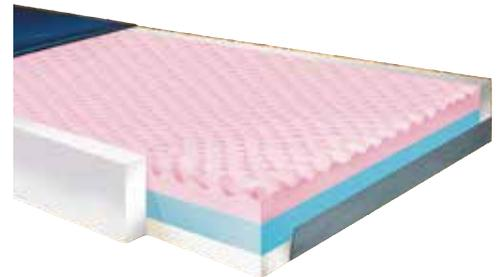

Standard Care Foam Mattress

Features:

- › Effective for the prevention of pressure ulcers
- › Nylon cover is fluid proof, flame retardant, antimicrobial, antistatic and easy to clean
- › Meets California technical bulletin #117 flammability requirements, optional California #129 and California #603 flame retardant available
- › Designed to meet the requirements of HCPCS code: E0184
- › Weight Capacity: 300 lbs.



Standard Care

35"x75"x6"	200-700 \$144.74
35"x80"x6"	200-701 \$144.74
35"x84"x6"	200-702 \$144.74
35"x75"x6" with Zipper Cover	200-703 \$140.00
35"x80"x6" with Zipper Cover	200-704 \$140.00
35"x84"x6" with Zipper Cover	200-705 \$140.00

for the road ahead
drive



Therapeutic Foam Pressure Reduction Support Mattress

The Drive Medical Therapeutic 5 Zone Support Mattress is a deluxe, horizontal, cross-cut, 5 zoned foam mattress which provides comfort, support and pressure redistribution. It comes with a best in class, 2-way stretch cover that reduces friction and shear, and is water resistant and vapor permeable, ensuring user comfort.

Features:

- › Best in class 2-way stretch cover reduces friction and shear, and is water resistant and vapor permeable
- › Deluxe, horizontal, cross-cut, 5-zoned foam mattress provides comfort, support and pressure redistribution

Therapeutic Pressure Reduction Support Mattress
36"x80"x6" **206-525 \$115.00**



for the road ahead
drive

Long Term Care Pressure Redistribution Mattress

The Gravity 7 Long Term Care Pressure Redistribution Mattress by Drive Medical uses a multi-layered, high density foam to provide optimal pressure redistribution for individuals in long term care facilities. The top layer of foam is high resilient and die-cut, which provides comfort and proper pressure redistribution. The ultra-soft heel section is uniquely designed to provide extremely low skin interface pressure, preventing pressure ulcers. The mattress cover is a 2-way stretch, water resistant, vapor permeable nylon ensuring users comfort and hygiene. The cover provides a low moisture transmission rate (MVT) which keeps the patient cool, dry and comfortable. The optional 3" elevated perimeter prevents patient falls and the Cut Out sections facilitates easy transfers in and out of bed.

Long Term Care Pressure Redistribution Mattress
36"x80"x6" **206-526 \$156.09**

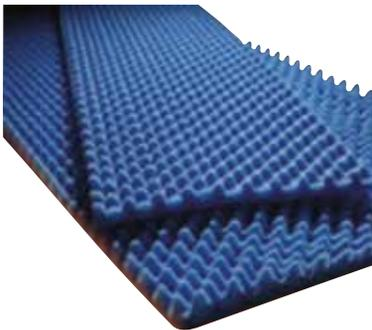

Eggcrate® Convoluted Overlays

Convoluted Overlay

33"x72"x2"	206-511	\$11.75
33"x72"x3"	206-512	\$15.28
33"x72"x4"	206-513	\$21.92

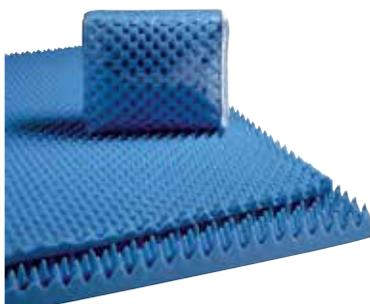

Eggcrate® Mattress Pads

Mattress Pad

2" Twin	206-500	\$36.67	3" Queen	206-507	\$71.67
2" Full	206-501	\$46.67	3" King	206-509	\$75.71
2" Queen	206-502	\$51.67	4" Twin	206-510	\$58.33
2" King	206-504	\$65.00	4" Full	206-515	\$81.43
3" Twin	206-505	\$39.17	4" Queen	206-516	\$88.57
3" Full	206-506	\$63.33	4" King	206-518	\$115.71

Geo-Matt® Therapeutic Overlay

The #1 selling therapeutic foam overlay in the U.S.

Used by thousands of hospitals and nursing homes throughout North America. It's innovative, clinically proven design provides economical yet effective performance in a wide variety of care settings. Comes with Soft Skin® Sleeve that protects the overlay. The cover is vapor permeable but resistant to liquids, and doesn't interfere with support surface function.

Therapeutic Overlay

33"x72"x3½" with Soft Skin Sleeve	206-160	\$89.95
Extra Soft Skin Sleeve	206-161	\$18.56 a pack of 12

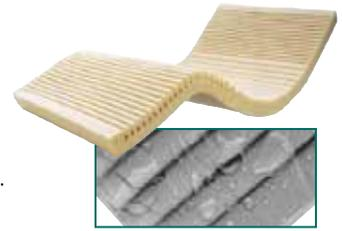

Soft Skin Sleeve

Premium Guard 3" Gel/Foam Overlay

Features:

- › Ideal combination of 4 gel bladders, high density foam shell and support base
- › Convuluted, high density polyurethane foam topper
- › Cover is made from a soft, nylon, urethane coated non-vapor permeable material
- › Bladders contain an aqueous non-toxic gel

Gel/Foam Overlay	206-158	\$109.00
-------------------------	----------------	-----------------



Premium Guard Static Air Flotation Overlay

The Premium Guard Static Air Mattress Overlay by Drive Medical's unique construction allows for efficient air flow throughout the mattress for use in the treatment and prevention of pressure ulcers. The air flow holes in the mattress, reduce heat and fluid build up, ensuring that the affected areas remain well ventilated and dry for proper healing. The adjustable bed straps prevent the mattress from moving and ensuring user safety and comfort.

Air Overlay

Air Mattress Overlay 72" x 35" x 2.5"	206-630	\$31.75
Manual Pump	206-616	\$17.74
Electric Pump	206-617	\$97.06



Prodigy Mattress Overlay

Features:

- › The air cells can be adjusted to address the specific needs of the patients body shape and size
- › No external power source required to operate effectively
- › Made of durable polyvinyl and can easily be cleaned with soap and water
- › Size - 81.5" x 35.5", fits standard size hospital or homecare beds

Mattress Overlay	707-525	\$319.00
-------------------------	----------------	-----------------





\$64.95



Med Aire Deluxe Alternating Pressure System

Features:

- › Quiet pump technology alternately inflates and deflates the pads air cells
- › Pump produces 4LPM air flow
- › Pad is made of heavy gauge premium vinyl
- › Pad size: 78"x34", › Weight Capacity: 300 lbs.



APP System

Pump & Variable Pressure Pad	206-162	\$69.95	Pump for 206-162	206-164	\$64.00
Pump & Fixed Pressure Pad	206-163	\$64.95	Pump for 206-163	206-165	\$56.88
			Filters for Pumps	206-166	\$15.00

\$385.00



Med Aire Low Air Loss 8" Mattress

The high volume pump produces 8 liters per minute of pressure to allow fast inflation. LED indicators provide critical performance data and alarm caregiver when pressure falls below 5 mmHg. Spring-loaded air tubes prevent kinks and disruption of air pressure. CPR valves provide fast release of air from the mattress to conduct CPR. Waterproof cover provides mattress protection and ventilation.

Med Aire

System Complete	200-875	\$385.00
Mattress only	200-876	\$362.00
Pump only	200-877	\$174.00



\$849.00



Med Aire Plus Alternating Pressure Mattress

Features:

- › Mattress can be used as static or alternating pressure device
- › LED and Audible alarm activates when pressure falls below 10 mmHg
- › High volume pump produces 8 liters of air per minute
- › Mattress has 20 Air cells, 9 with micro laser holes
- › Constructed with quilting nylon/PU coating and stretch Nylon with removable zippered cover
- › CPR emergency valve provides fast release of air

Med Aire Plus

Standard 8", 450 lbs	200-885	\$849.00
Bariatric 10", 600 lbs	200-887	\$1259.00



Med Aire Plus Alternating Pressure Mattress with Defined Perimeter

Features:

- › Specially designed air supply manifolds quietly operate alternating pressure and air loss systems, while maintaining firm "Defined Perimeter".
- › LED and Audible alarm activates when pressure falls below 10 mmHg
- › "Whisper Quiet" pump produces 8-LPM (Litres per Minute) in air flow.
- › Mattress has 20 Air cells, 9 with micro laser holes
- › CPR valves provide fast (20-Second) deflation.

Defined Perimeter **200-888** **\$944.44**



LumexAir Low Air Loss Mattress and Pump



The LumexAir from Lumex is a full replacement mattress system comprising twenty (20) deep flotation air cells positioned horizontally over a 2" foam base. Air cells offer an 8" cell depth and can be individually replaced as required. CPR deflation is accomplished by simply disconnecting air lines from pump to release air. Battery operated power loss alarm.

LumexAir **200-880 \$2,259.00 DISC.**

Stretcher Pads

Covered with Sure-Check Fusion III developed in cooperation with healthcare professionals to provide a comfortable, safe and effective use in healthcare facilities. Sure-Chek fabrics are the original healthcare fabrics and have always been the standard in the industry. They are reinforced to be strong and durable as well as antimicrobial to protect the fabric, anti-static, flame resistant, stain and odor resistant and impermeable. Meets California #117 and National Fire Protection Agency (NFPA 701, large scale) requirements.

Square Corner Pad

24"x75"x2"	223-900 \$135.42
24"x75"x3"	223-901 \$150.18
24"x75"x4"	223-902 \$168.99
26"x75"x2"	223-903 \$135.42
26"x75"x3"	223-904 \$150.18
26"x75"x4"	223-905 \$168.99
28"x75"x2"	223-906 \$168.01
28"x75"x3"	223-907 \$178.51
28"x75"x4"	223-908 \$189.36

Cut Corner Pad

24"x75"x2"	223-909 \$135.42
24"x75"x3"	223-910 \$150.18
24"x75"x4"	223-911 \$168.99
26"x75"x2"	223-912 \$135.42
26"x75"x3"	223-913 \$150.18
26"x75"x4"	223-914 \$168.99
28"x75"x2"	223-915 \$168.01
28"x75"x3"	223-916 \$178.51
28"x75"x4"	223-917 \$189.36



Cut Corner

Spenco Comfort Touch

Spenco Comfort Touch pressure reduction products are made from soft, fluffed hollow core fibers called Silicore® fibers. They help reduce pressure, don't matt down, and provide insulation against heat and cold. These fibers are permanently siliconized to help absorb friction and prevent moisture penetration. Products made with Silicore® padding are machine washer/dryer safe. Spenco Comfort Touch pads have waterproof sheeting on one side (ideal for incontinent situations) and cotton/polyester on the reverse side.



Comfort Touch

Seat	191-042 \$55.55
Bed	191-043 \$142.86



\$55.95

No-Gap Full Rail

Features:

- › Attractive brown vein finish
- › Constructed of 1" steel
- › Telescopes with movement of bed
- › Easily adjusts up or down with spring-loaded release
- › Spring-loaded crossbars are easy to install and remove

Full Rail **201-222** **\$55.95 a pair**



Tool Free Adjustable Length Bed Rail

Features:

- › Adjusts between 36" and 72"
- › Attractive brown vein finish
- › Constructed of 1" steel
- › Crossbars are easy to install and remove
- › Crossbars come with extensions that will accommodate a KING SIZE BED
- › Easily adjusts up or down with spring-loaded release
- › Fits all home style beds
- › Rail length can be adjusted without tools to 37", 43" or 57" long



Adjustable Length Bed Rail **201-225** **\$82.13 a pair**

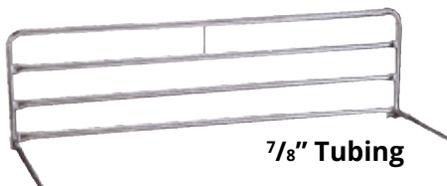

7/8" Tubing



1" Tubing

Telescoping Full Rails



Safety Bed Rails are one of the most important security and accident prevention accessories used in the patient room today. That's why Invacare designs all thier safety rails to withstand heavy-duty use. Double chrome plated welded construction. Easy to attach to beds. The rails adjust up or down with simple pull button release. Spring loaded, self adjusting cross braces. Designed to meet all your needs.

Telescoping Rails

Standard 7/8" Tubing **201-105** **\$80.57 a pair**

Universal Crossbraces

Works in conjunction with other manufactures hospital bed rails, including Lumex, Scio-Tech, Everest & Jennings and some Invacare and Smith & Davis models.

Crossbraces

For 7/8" O.D. Tubing **211-906** **\$48.28 a pair**
 For 1" O.D. Tubing **211-902-BV** **\$71.97 a pair**





Half Rail

Features:

- › Attractive brown vein finish, constructed of 1" steel
- › Fits all hospital beds with steel frames
- › Ideal for maximum protection when bed is elevated
- › Easy to install

Half Rail **201-217 \$55.95 a pair**



\$55.95

T Style Half Rail

Features:

- › Attractive brown vein finish, constructed of 1" steel
- › For use with "Pan-Style" and Bariatric beds
- › Ideal protection without confining the patient
- › Provides maximum protection when bed is elevated

Half Rail **201-216 \$81.23 a pair**



Half Rails



Safety Bed Rails are one of the most important security and accident prevention accessories used in the patient room today. That's why Invacare designs all there safety rails to withstand heavy duty use.

Features:

- › Designed to meet all your needs
- › Double chrome plated 1" tube, welded construction
- › Easy to attach to beds
- › The rails adjust up or down with simple pull button release
- › Nylon coated flat channel crossbraces



Tube Tree

The Tube Tree safely and neatly routes all tubes, lines and cables from medical equipment to the patient. With these items out of the way, there is less chance of crimping, rolling over or pulling out tubes, lines or cables. The design clamps securely to most bed rails and I.V. poles. The product is made in the U.S. from indestructible polycarbonate and is resistant to all medical grade cleaners and disinfectants.

Tube Tree **275-720 \$30.83**





Security Rail for Home Beds

Secures against rolling out of bed. The rail is 30" long with a height of approximately 8" above the mattress. The rail is powder coated and made of steel for strength. The rail lowers by depressing snap buttons.

Security Rail

- Fits Any Size, 1 side **201-402 \$69.95**
- Fits Twin thru Full, 2 sides **201-401 \$99.95 a pair**



Reversible SlantRail for Home Beds

The new SlantRail is reversible, this unique bed rail provides two different handles in one. Depending on the need of the patient this handle provides a wide range of grasp and leveraging positions to better help promote bed mobility. The two tubular support tubes go far under the mattress with foam wraps to prevent handle slippage.

SlantRail **201-400 \$55.95**



Bed Cane

Features:

- › Free organizer with Bed Cane
- › Adjustable height, adapts to appropriate height for varying mattress thickness
- › Wide handle design allows for variety of grip positions
- › Steel components with powder coat finish provide long lasting quality
- › Handle folds down for storage and portability
- › Safety strap secures solid wood base to mattress
- › Installs on either side of the bed



Bed Cane **201-354 \$64.95**

30" Pivot Safety Half Length Bed Rail

Features:

- › Collapsible rail folds down to side of bed to allow user to get out of bed or provide space for making bed
- › Reversible - Can be placed on either side of the bed

Specifications:

- › Width of Rail: 30"
- › Height of Rail: 23" high from the base of mattress
- › Gap between Rails: 3"
- › Attaches to any home or hospital bed with safety strap
- › Weight Capacity: 400 lbs



Pivot Rail **201-209 \$79.95**

Bed Rail Advantage

Feature:

- › Free Organizer
- › Pops out of the box ready to be placed on any bed
- › Heavy duty steel with powder coat provides long lasting quality
- › Handle folds down for storage and portability
- › Safety strap secures base to bed frame and mattress
- › Foam grip handle, closed cell foam is easy to sanitize
- › Fits on either side of the bed



Bed Rail Advantage **201-364 \$63.95**

AssistaRail

The AssistaRail™ is an “inverted U” style bed rail for home beds, providing a unique combination of occupant safety and in-bed mobility

Benefits:

- › Easy Installation - Entire “inverted U” shaped rail installs in minutes with basic tools, simply slides between mattress and box spring. Safety strap and anti-slide grips hold rail from shifting during use
- › Sleep Safely - Effective rail design allows for in-bed mobility and bed queuing (gives an idea of where the mattress edge is located)
- › Transfer Safely - Optional AssistaCane, can be attached to the AssistaRail, providing a fixed gripping surface for improved standing support that reduces wrist strain or upper body twisting
- › Comfortable Foam Grip - Long durable grip covers both horizontal and vertical parts of the rail to allow versatile gripping and handling (non-latex material)

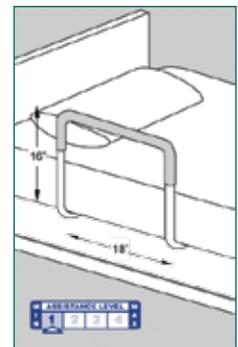

Rail legs extend 24” under mattress

AssistaCane

The AssistaCane™, is a fixed handle providing solid support for transferring in and out of bed. It provides a surface that minimizes wrist strain and twisting during transfer operations.

AssistaRail

Standard **201-370 \$90.00**

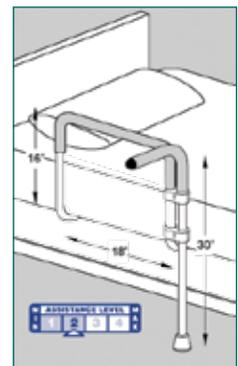

Rail legs extend 24” under mattress

SuperPole

The SuperPole system should only be installed between floors and ceilings of solid construction or injury may result. The SuperPole system should not be installed on loose floor coverings, in rooms with radiant ceiling heating, in mobile homes, or in suspended or angled ceilings. Recommended weight limits are 250 lbs. / 114 kg for all models; no more than 150 lbs. / 70 kg. should be exerted on trapeze system (for repositioning and sitting up assistance only).

Features:

- › Ease of installation, can be installed or relocated with out drilling, screws or damage to the floor or ceiling
- › SuperPole can be installed in virtually any area of a room, exactly where it is needed. Custom heights of 120" to 140" are available
- › High quality, durable hand grip, particularly useful for limited grip strength
- › Clean and modern design blends with any home decor
- › Secure, rubber pad interface on both top and bottom
- › Can be used beside a bed, bath, toilet or chair
- › Toe friendly, small, low profile base plate does not interfere with movement
- › Heavy gauge steel construction

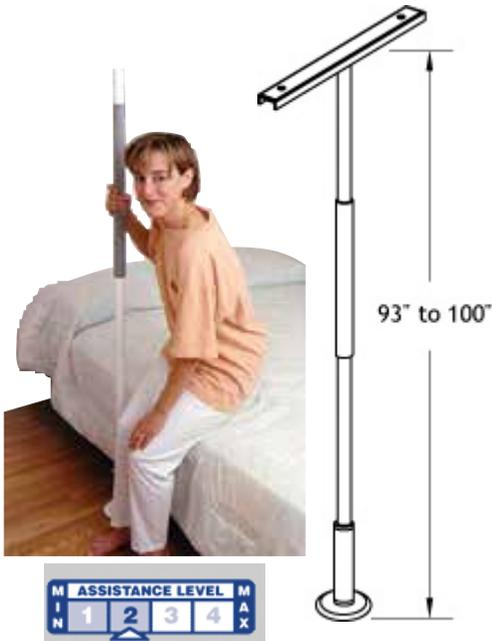

SuperBar

Unlocks and pivots freely to move with you step by step, yet locks every 45 degrees to assist with standing and sitting. Automatically locks when released preventing forward or lateral falls. Full support when taking two or three steps. Works for the Bedroom or at the Bathtub and Toilet.

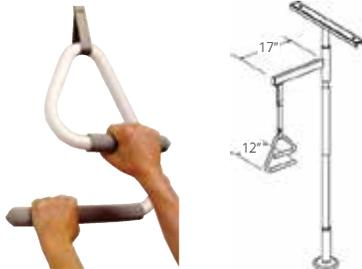
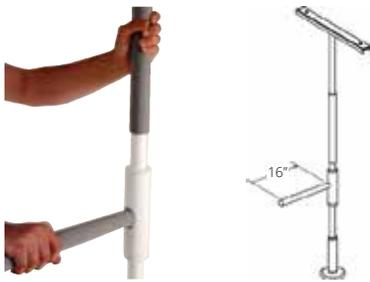

SuperTrapeze

Includes the innovative e2 trapeze handle with a "ladder like" set of two rails that allows the user to more easily climb up to a sitting position. Unable to be used with Extension Tube.



SuperTray

The plastic tray and non-slip pad can be removed for cleaning or transporting meals. Frame snaps on at virtually any height, tray frame pivots around the pole.

SuperPole

- 250 lbs. Weight Capacity
- 450 lbs. Weight Capacity
- Extension Tube for 201-357 (increases range from 99" to 121")
- SuperBar add-on
- SuperTrapeze add-on
- SuperTray add-on

- 201-357 \$164.47**
- 201-358 \$296.05**
- 201-362 \$78.33**
- 201-359 \$108.57**
- 201-360 \$134.29**
- 201-361 \$134.29**

Firmly supported by a simple jackscrew expansion between floor and ceiling, the SuperPole gives a generous range of fit.



Bed Rail Pads

Made with naugahyde, 1" foam, and ties for quick attachment to bed rail. Special sizes available upon request. Adds extra comfort for patient by covering hard metal bars with attractive 1" pad. Specify color from page 158



Bed Rail Pads

- 14"x48" **202-1CL \$67.21 a pair**
- 14"x60" **202-2CL \$66.90 a pair**
- 14"x70" **202-6CL \$72.16 a pair**

Adjustable Blanket Support

Features:

- › Protects sensitive skin areas
- › Keeps blanket off the feet to prevent foot cramping
- › Made of a tubular frame base
- › Inserts between the box spring and the mattress
- › Rests on top of the mattress when not in use
- › Height adjusts up to 19", frame is 20"x6"



Blanket Support 209-004 \$21.70

Elbow Pads

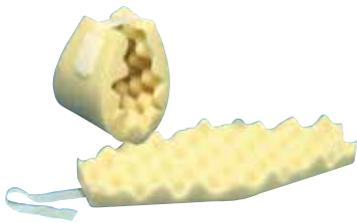

Elbow Protector
 206-201 \$6.50 pr



Elbow Pillow
 206-400 \$37.18 pr

Foot Pads



Heel Protector
 206-200 \$7.23 pr



Foot Pillow
 206-401 \$27.57 pr

Positioners



Donut Positioner 206-202 \$5.25



Positioning Roll 206-205 \$7.33



Body Aligner Wedge
 No Cover **206-203 \$8.45**
 Naugahyde Cover **202-3CL \$46.35**



Head Support 206-204 \$7.60



Abduction Pillow 206-207 \$63.83

Choose color from page 158



Perfect Rest™ Pillow

A combination pillow that provides comfort and support. For your tired, aching or stiff neck, try this dual-density fiber support pillow. It combines an extra firm roll that supports the neck and shoulders with a soft cushioning area to support the head. This combination makes this pillow comfortable to rest on at night while getting proper support. Filled with cool Corefill® polyester fiber.

Pillow

22"x23" Perfect Rest

202-913 \$30.82



Tri-Core® Pillow

Recently, 97% of doctors surveyed agreed that the Tri-Core pillow gives proper sleeping support. Now filled with antimicrobial fiber, the Tri-Core is absolutely the highest quality fiber cervical pillow available today. Enjoy all the comfort of a premium pillow with the positive advantages of proper neck support. Each pillow is handcrafted with the premier, first quality, Fortrel® BactiShield® antimicrobial fiber. Designed for either back or side sleeping, the Tri-Core is so comfortable that we're sure you'll sleep on it every night! Choose the Gentle Tri-Core for softer support!

Pillow

24"x16" Standard Tri-Core (firm)

202-910 \$30.47

24"x16" Gentle Tri-Core (soft)

202-911 \$30.47

Pillowcase (blue cloud)

202-912 \$11.37



Basic Cervical Pillow™

You'll wake up refreshed when you sleep on this pillow. The pillow has two different support lobes; choose the size that's comfortable for you. Features a smooth surface, standard support.

Pillow

22"x16" Basic Cervical (firm)

202-918 \$25.22

22"x16" Gentle Basic Cervical (soft)

202-919 \$25.22

Pillowcase (blue cloud)

202-912 \$11.37



Econo-Wave™ Pillow

A popular foam pillow that gives you support at an economical price. Econo-Wave is a cervical pillow with a waved, or rippled surface. The waves provide even support and allows air to circulate while soothing your neck. The variable lobe sizes allow your neck to rest comfortably in its natural position.

Pillow

22"x16" Econo-Wave

202-920 \$38.88

Pillowcase (blue cloud)

202-912 \$11.37



Memory Plus Pillow™

Finally, a memory pillow that promotes proper sleeping posture. Giving you a soothing customized fit, the memory foam top conforms to your head. The resilient foam base provides full support, offering therapeutic value not found in other memory foam pillows. Covered with an attractive blue pillowcase.

Pillow

18"x13" Memory Plus

202-933 \$50.22

Core Roll™

Our most versatile fiber filled positioning pillow. The hand crafted Core Roll has a gentle center and firm ends to ensure maximum comfort and proper support. Its size and shape allow you to use it for your neck, back or under your knees. Useful at home or when traveling.

Core Roll

17"x7" **202-921 \$19.15**
Pillowcase (blue) **202-922 \$10.72**



Leg Spacer®

The Leg Spacer is designed to help relieve pressure and strain on the lower back, knees and ankles. The unique, hourglass shape moves with you when you turn over, eliminating the need to strap the product to your legs. Covered with a cotton/poly, blue cloud pattern fabric. Patent #5,216,771

Leg Spacer

Standard 10"x8"x6" **202-930 \$28.45**
Petite 9"x6¹/₂"x5¹/₂" **202-931 \$28.45**



Knee Elevator

This simple foam knee positioning wedge is an excellent support for the reduction of circulatory problems, knee pains and low back pain. Combine this positioning pillow with a quality Core cervical pillow and you may have found the perfect nights sleep.

Knee Elevator

17"x10"x7" **202-932 \$31.83**



Bed Wedge™

Our versatile foam Bed Wedge, originally designed for treatment of hiatal hernia, has become popular with people that find a normal bed uncomfortable. This wedge can be used to elevate either the upper body or legs, and in either a sitting or prone position. Covered with a cotton/poly, blue cloud pattern fabric.

Bed Wedge

24"x24"x7" **202-923 \$44.87**
24"x24"x10" **202-924 \$58.57**
24"x24"x12" **202-925 \$55.95**



Travel Core™ Pillow

Finally, you can sleep as well when traveling as you do at home. The Travel Core provides the support you need while sitting or lying down, and its compact size makes it easy to carry.

Pillow

18"x9" Travel Pillow **202-914 \$26.28**
Pillowcase (blue) **202-915 \$10.40**

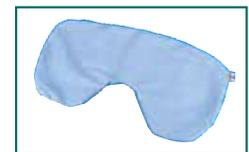



**Only
\$15.95**



Ocelco Pull String Monitor

The newly redesigned Ocelco string monitor provides unparalleled value that is rich in features and low in cost. The case is constructed of a durable ABS plastic that can withstand the rigors of institutional use. All the alarm settings are located inside the battery compartment making the monitor compliant with JCAHO standards. The mounting clip is now made of an indestructible stainless steel and is Guaranteed Not To Break! The pull cord is adjustable in length. A new unique alarm tone provides differentiation from other alarms in the facility, such as door or wandering alarms. The battery compartment features a hinged design that is permanently attached to the case. No more lost battery covers! The cover also features a dual function closure, including a snap-to-close design as well as a screw for increased tamper resistance.

	Reg.	Sale
Pull String Monitor	305-461 \$19.14	\$15.95
Replacement Magnet Assembly, 5 pk	305-463 \$35.98	\$29.98



Ocelco Basic Alarm with Choice of Pad

The new Basic Monitor features an Off/Lo/Hi switch on the side of the monitor to control alarm function. A strain relief helps to protect both the monitor and the sensor pad connector from damage. The Basic monitor is an excellent entry level upgrade from string monitors.

	Reg.	Sale
Basic Alarm		
with 45 Day Chair Pad	305-466-4C \$59.78	49.82
with 1 Year Chair Pad	305-466-1C \$75.14	62.62
with 45 Day Bed Pad	305-466-4B \$64.74	53.95
with 1 Year Bed Pad	305-466-1B \$82.04	68.37



Ocelco Advanced Alarm with Choice of Pad

The New Advanced Monitor has many features including: Hi/Lo/Remote alarm volume, 0-2 second alarm delay, Optional AC adaptor, built in strain relief helps to protect the monitor and sensor pad connector from damage. Reset button is discretely located on the side of the monitor. All alarm controls are located inside the battery compartment making the monitor compliant with JCAHO standards.

	Reg.	Sale
Advanced Alarm		
with 45 Day Chair Pad	305-467-4C \$74.64	\$62.20
with 1 Year Chair Pad	305-467-1C \$90.00	\$75.00
with 45 Day Bed Pad	305-467-4B \$79.60	\$66.33
with 1 Year Bed Pad	305-467-1B \$96.90	\$80.75

AC Adaptor for Advanced Alarm	305-464	\$21.10	\$18.33
--------------------------------------	----------------	----------------	----------------

Universal Chair Exit Alarm Pads

The Universal Sensor Pad is compatible with most brands of fall monitors. Pad measures 14.5" wide x 10" deep.

***Note:** It is the caregiver's responsibility to test monitor compatibility with Universal Sensor Pads.

Universal Chair Pads

		Reg.	Sale
45 Day Chair Pad	305-457-CH	\$18.54	\$15.45
1 Year Chair Pad	305-458-CH	\$33.90	\$28.25
45 Day Chair Pad, 6 Pack	305-468-CH	\$95.99	\$79.99
1 Year Chair Pad, 6 Pack	305-469-CH	\$182.51	\$155.99



Universal Bed Exit Alarm Pads

The Universal Sensor Pad is compatible with most brands of fall monitors. Pad measures 28.25" wide x 10" deep.

***Note:** It is the caregiver's responsibility to test monitor compatibility with Universal Sensor Pads.

Universal Bed Pads

		Reg.	Sale
45 Day Bed Pad	305-457-BD	\$23.50	\$19.58
1 Year Bed Pad	305-458-BD	\$40.80	\$34.00
45 Day Bed Pad, 6 Pack	305-468-BD	\$143.99	\$119.99
1 Year Bed Pad, 6 Pack	305-469-BD	\$220.79	\$183.99



Shock Absorber for Ocelco Exit Alarms

The Shock Absorber is designed to absorb the impact from accidental droppings. Helps to greatly increase the life expectancy of Ocelco Exit Alarms. Fits all Ocelco Exit Alarms.

		Reg.	Sale
Shock Absorber	305-462	\$7.98	\$6.65



Universal Mounting Clip for Head and Footboards

Fits all Ocelco Exit Alarms.

		Reg.	Sale
Mounting Clip	305-465	\$9.98	\$8.32



AC Adaptor for Ocelco Advanced Alarm

Only works with the Ocelco Advanced Fall Prevention Alarms

		Reg.	Sale
AC Adaptor	305-464	\$21.10	\$18.33



UMP Economy Pull String Alarm for Bed or Chair



Features:

- › Pull-string magnet monitor that alarms when unsupervised resident movement occurs
- › Attaches to a bed or chair, and the exclusive "Safety Klip" is attached to the resident
- › Alarm sounds when the magnetic seal is broken between the monitor and the magnet
- › No on/off switch

Pull String Monitor **305-317** **\$15.60**
Cushion Protector **305-352** **\$5.92**

UMP Bed Sentry Standard Monitors



Bed Monitor

Features:

- › Dual button reset; must be pressed simultaneously to silence alarm
- › Volume and delay switches inside battery compartment
- › No on/off switch
- › Self-timing pad use with monitor enables visual and audible indicators for pad expiration
- › Built-in Sentry cord stain relief
- › Low battery indicator
- › Uses single 9V battery, bed model also has DC adapter jack
- › Selectable 4-tone alarm
- › Bed model has nurse call with remote reset alarm option

Sentry Standard Monitors
 Bed Monitor **305-313** **\$40.00**

Now Featuring Online Ordering www.ocelco.com

Online Store Features:

- Cash Rewards -** **Order Online and SAVE Money with Ocelco Cash Reward Points, See Website for More Details.**
- E-mail Specials -** **Internet Only Specials E-mailed Weekly, Not Receiving Them Call to be Added.**
- More Products -** **Products Updated and Added Daily.**

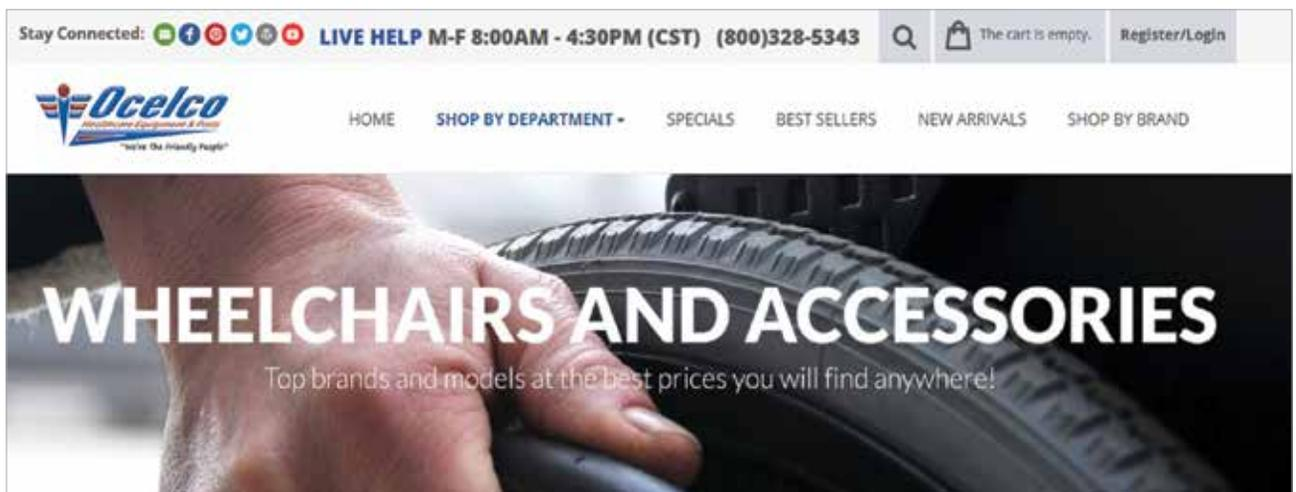



Bed Pad



Chair Pad

UMP Standard Sensor Pads

Features:

- › Extra large size on bed pads helps to limit false alarms
- › Durable vinyl cover cleans easily
- › Compatible with all UMP monitors

Standard Bed Sensor Pads (10" x 30")

45 Day Pad	305-320-45	\$23.33
1 Year Pad	305-320-01	\$38.33

Standard Chair Sensor Pads (7" x 15")

45 Day Pad	305-321-45	\$17.50
1 Year Pad	305-321-01	\$33.33



Bed Pad

UMP Timed Sensor Pads

Features:

- › Timer automatically begins after being plugged into equipped monitor
- › Number of days remaining in usage period visually displayed
- › LCD begins flashing when only 3 days remain and monitor emits a short audible alarm once per minute

Timed Bed Pads (10" x 30")

1 Year Pad	305-325-01	\$43.33
------------	-------------------	----------------

Micro-Tech Sensor Pads

For use with all Micro-Tech fall monitors



Micro-Tech Wide Sensor Pads

1 Year Pad	305-320-01	\$38.33
------------	-------------------	----------------

Universal, Overbed Table Vanity



Features:

- > Two way design
- > Fits 15" wide top
- > Non-breaking acrylic mirror
- > Comes with attaching hardware
- > Dual compartments

Vanity

without Mirror **213-102 \$46.67**
 with Mirror **213-103 \$65.83**

Pivot and Tilt Overbed Table



Features:

- > Folds up for easy storage
- > Tabletop is 23½"x15¾"
- > 3 Locking Mast Positions - 30, 60 and 90 degrees
- > 7 Locking Table Positions
- > Height adjusts from 28"-37"
- > Base is 25"x25"
- > 4 Casters (2 locking, 2 non-locking)

Table 203-112 \$74.38



\$54.95

Standard Overbed Table



Easily assembled. Height adjusts 14½". Swivel casters provide a smooth rolling action. Walnut, wood grain laminated 31" top on ¾" particle board core with plastic edge molding. Silver Vein finish "H" base and column for aesthetics and durability.

Table 203-106 \$55.89



\$71.95

Tilt-Top Overbed Table



Easily assembled with three bolts. Chrome plated and welded tubular steel column and base make the table durable and stable. 1½" hooded, ball bearing casters provide easy maneuverability across all floor surfaces. Table top adjusts 1¾" in infinite positions and is constructed of oak, wood grained Melamine laminate on ¾" particle board core. Raised T-Molded plastic edge. Chrome plated "H" base and column for aesthetics and durability.

Table 203-200 \$74.55



Auto-Touch Overbed Table



Light upward touch on patented spring loaded locking handle allows table to elevate freely. Light downward touch on table top locks table in position. Unique "C" base design permits use with chairs. Attractive walnut wood grained laminate top with flush mounted T-molded edge. Durable, heavy gauge, chrome plated welded tubular steel construction.

Table

Standard Top with "C" Base **203-108 \$69.95**
 Tilt Top with "H" Base **203-110 \$74.95**

Replacement Overbed Table Tops

Available in English Oak. Specify type when ordering, unspecified orders will be shipped walnut.

Replacement Table Top

14¾"x28½" **213-100 \$28.95**
 15"x35" **213-101 \$79.95**

Mayo-Instrument Stand

Double Post Features:

- › Removable stainless steel tray measures 19"x12½"
- › Adjustable height from 34" to 54½"
- › Two hooded casters

Mayo Stand 203-116 \$98.26



Goose Neck Exam Lamp

Features:

- › 16" flexible goose neck arm adjusts 360 degrees
- › 3-prong plug
- › Adjustable height: 48" - 72"
- › For use with incandescent light bulbs up to 60 watts
- › Goose-style neck allows the lamp to be adjusted in any direction
- › UL listed
- › Weighted, steel base prevents tipping

Goose Neck Exam Lamp 303-131 \$73.47



Foot Stool

Features:

- › Steel welded, chrome plated construction
- › Non-slip ribbed rubber platform

Standard 303-304 \$26.72
Bariatric, 500 lbs 303-312 \$42.14



Physical Therapist Stool

Features:

- › 18" fixed height
- › 3" gray padded seat
- › Chrome plated steel construction

Stool 288-163 \$69.44



Safety Bar Foot Stool

Features:

- › Chrome plated handrail provides additional support and safety
- › Steel welded chrome plated construction
- › Non-slip ribbed rubber platform

Safety Bar 303-305 \$44.77



Hamper with Foot Pedal

This single hamper is constructed from 7/8" steel tubing with a bright and sturdy chrome finish. White ABS high impact lid. Bag lock secures liners in place. (Bags not included.) Four 3" quiet-ride casters insuring smooth rolling, two are locking to secure the hamper in place. Lock secures liners in place. (Bags not included). Includes four 2" hooded ball casters. 18"L x 17"W x 35"H

Hamper 312-025 \$127.33
Nylon Bag 312-028-CL \$56.20
Antimicrobial Bag 312-029-CL \$67.03



Hamper Stand

This hamper is constructed from heavy-duty 3/8" wire with a sturdy zinc finish. Hamper assembles in minutes by securing bottom shelf and lid wires to allow for hands-free operation of the white ABS high impact lid. Bag lock secures liners in place. (Bags not included). Includes four 2" hooded ball casters. 18½"L x 17¾"W x 37"H

Hamper Stand 312-026 \$111.27
Nylon Bag 312-028-CL \$56.02
Antimicrobial Bag 312-029-CL \$67.03



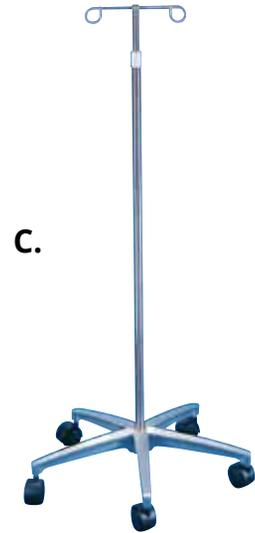
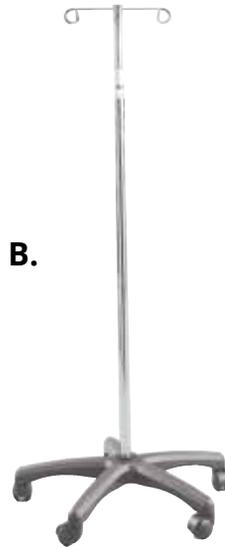
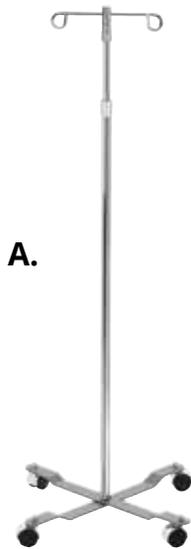

I.V. Poles

- A. Select Care:** Low profile base prevents tipping. Chrome plated steel. Height: 46 $\frac{1}{4}$ " to 85"
- B. Deluxe 5-Leg:** Chrome plated, steel I.V. pole height adjusts 38 $\frac{1}{4}$ " in 1" units. Five-leg base offers maximum stability. Base is molded of unbreakable, truss-reinforced plastic. Sure-Grip clutch nut provides a full range of height positions.
- C. Stainless Steel Deluxe 5-Leg:** Circular, Ram-Horn hooks provide secure suspension of solution containers. Friction-grip lock permits height adjustment without danger of slipping. 2-hook pole. Height: 48" to 86"

Select Care I.V. Pole

2 Hooks	308-001 \$32.33
4 Hooks	308-004 \$41.75

Deluxe 5 Leg I.V. Pole

2 Hooks	308-005 \$50.97
4 Hooks	308-006 \$58.02

Stainless Steel Deluxe 5 Leg I.V. Pole

2 Hooks	308-003 \$85.71
---------	------------------------



I.V. Ceiling Pole

Adjustability: The I.V. Ceiling Pole is permanently affixed to the ceiling and it easily turns both ways 360° and moves over the bed in either direction on its own track. The I.V. support pole is completely movable and telescopic, allowing it to be locked into position at any height needed by a simple twist of the wrist.

Comfort and Safety: With more freedom of movement, the patient is able to rest in any chosen position. The device provides greater safety, removing the risk of accidental tipping.

Practical: The I.V. Ceiling Pole does not take up any valuable floor space, either in the intensive care unit or the patients room, facilitating foot traffic and circulation in the area.

Hygienic: Being anchored to the ceiling, this I.V. pole eliminates direct contact with children, other nonprofessionals and the danger of passing contagious disease and infections.

Trapeze Bar & Base

Features:

- > Can be mounted to metal frame beds or used with stand
- > Weight Capacity: 250 lbs.

Drive Trapeze

Silver Vein Square Tubing Bar	204-206	\$102.65
Chrome Plated Square Tubing Base	204-201	\$92.76

Lumex Trapeze

Gray Coated Square Tubing Bar	204-202	\$95.90
Gray Coated Square Tubing Base	204-204	\$74.95

Invacare Trapeze

Chrome Plated Octagon Tubing Bar	204-300	\$99.95
Chrome Plated Square Tubing Base	204-301	\$99.95



Trapeze Bar
\$94.95



Trapeze Base
\$74.95

Heavy Duty, Trapeze Bar & Base

Features:

- > Four piece sub-assembly significantly reduces set up time.
- > 600 lb. patient weight capacity

Trapeze 204-335 \$895.00



Cervical Traction Set

This cervical traction set by Drive Medical features a heavy-duty head halter for over door use. The halter includes several items to make use easier: a metal support; self-attaching closures; a 12" adjustable spreader bar; an 8' traction rope; double-sealed rings; water bag; and "S" hook. The set is one-size-fits-all and comes machine washable for additional convenience.

Features:

- > Complete with 12" adjustable spreader bar, 8' traction rope, double-sealed rings, water bag and "S" hook
- > Machine washable
- > One size fits all
- > Fits over door



Traction Set 204-342 \$15.70



Drive Manual Patient Lifts



Compares to Invacare®* Model 9805

Features:

- › Easy to set up and disassemble
- › Pump handle rotates from side to side for attendant convenience
- › Padded swivel bar

Specifications:

Maximum Height:	64"
Minimum Height:	21"
Base Width (open)	42"
Base Width (closed)	22.5"
Weight Capacity:	450 lbs.



\$395.00

Hydraulic Patient Lifter 302-214 \$395.00

Note: Slings are not included with lifters, See page 118 for slings.



*(Not endorsed or authorized by Invacare®)

Classic Hoyer®



The Hoyer Lifter is designed to safely and comfortably transfer a person from bed to chair, commode or car protecting both the person being transferred and the attendant from strain or injury. Designed for easy operation, Hoyer lifters are available with interchangeable adjustable "U" or nonadjustable "C" bases with a chrome finish. Maximum Weight Capacity: 400 lbs.



\$544.00

Hydraulic Patient Lifter

"U" Base	302-110 \$544.00
"C" Base	302-111 \$744.00



Note: Slings are not included with lifters, See page 120 and 121 for slings.

Hoyer® Versatile



Features:

- › Non-sway cradle increases patient stability
- › Same durable rectangular tubing construction found on more expensive lifters
- › Full travel height range allows lifting from floor
- › Easy to adjust base legs lock securely into open and closed positions
- › Disassembles for easy storage
- › Manufactured by the most recognizable name in patient lifting
- › Accommodates Hoyer 4-point slings and traditional slings
- › Weight Capacity: 400 lbs.
- › Convenient rotating pump handle allows operation from both sides of lifter
- › Priced for reimbursement



\$584.00

Hydraulic Patient Lifter

Painted	302-120 \$559.00
---------	-------------------------



Note: Slings are not included with lifters, See page 120 and 121 for slings.

Electric Patient Lift

Features:

- › Heavy gauge construction
- › Jumbo actuator pump with emergency button can switch to manual mode lowers patient down safely
- › Fast, easy charge from AC outlet
- › Audible warning when battery power falls below 50%
- › The "CHARGE" light will automatically shut off when battery is fully charged
- › Foldable mast and base for easy storage and transportation
- › For use with 4 point and 2 point slings
- › Wide base provides additional stability
- › Lifting capacity: 450 lbs.



Specifications:

Maximum Height:	76"	Base Width (closed):	26.5"
Minimum Height:	26"	Weight Capacity:	450 lbs.
Base Width (open):	41"		

Electric Patient Lifter **302-216** **\$1,219.00**

Note: Slings are not included with lifters,
 See page 118 for slings.



\$1,219.00

Invacare Reliant Plus 450 Lifters

Battery Powered: Accommodates up to 450 lbs. Equipped with a quiet, long-life motor. Wide base for maximum stability. Easily charges overnight, with flashing light to signal charge.

Hydraulic-Lift: Pump mechanism allows transfers of up to 450 lbs. with minimal effort. Wide base for maximum stability. Comfortable handle placement for ease of use. Low maintenance.

Low-Profile: 4¼" under-bed clearance improves accessibility.

450 Lifters

Hydraulic, Low Profile	302-203	\$859.00
Battery Powered, Low Profile	302-204	\$1614.00



Note: Slings are not included with lifters,
 See page 119 for slings.



Hoyer® Deluxe Power Lifter

Designed to meet the needs of the caregiver as well as the patient, the lifter features ergonomic handle grips to reduce back strain and a mechanical down-release lever for non-powered lowering. The single-speed actuator is reverse-mounted to give the patient increased leg clearance, and the unit also features leg guards and caster bumpers to prevent damage to walls and furniture. Sunrise Medical guarantees this Hoyer® product with a 3 year limited warranty on the frame and a 1 year limited warranty on all other components excluding normal wear and tear items.

Specification:

Minimum Width:	24"
Maximum Width:	41"
Length:	43½"
Weight Capacity:	400 lbs.

Note: Slings are not included with lifters,
 See page 120 and 121 for slings.

Electric Patient Lifter
 "U" Base **302-436** **\$1,460.00**



\$1,460.00



PAGE 115
Electric Patient Lift
302-216

Drive Medical Stand-Assist Lift

This stand-assist lift by Drive Medical provides patients with safe, stable assistance while standing, transferring or toileting. A extra-wide, non-skid foot plate forms a stable base for foot positioning and a soft, padded adjustable leg support includes a support strap to secure legs. The lift includes a convenient four sling attachment points that enable the lift to accommodate a variety of stand-up sling designs. Its 24 V DC motor is powerful and reliable, featuring an emergency stop button and manual lowering device. The motor includes a removable rechargeable battery that charges quickly to eliminate down time. The battery, complete with a charge meter, will alert you both when charging is complete or when it may be necessary (below 50%) with an audible tone. Even transportation is simplified with easy-roll 4" casters that provide stability and easy maneuverability over a variety of surfaces. A 4.5" under-bed clearance allows the lift access under most long-term care beds.



\$1,695.00

Specifications:

Base Width:	Open: 40.2" Closed: 24.5"
Caster Options:	Front: 3" Rear: 4"
Overall Height:	Minimum - 26.2", Maximum - 81.1"
Base height:	4.5" (clearance)
Weight Capacity:	400 lbs.

Stand-Assist Lifter

Lifter	302-217	\$1,695.00
Stand-Up Sling	301-462-SZ	\$90.10
Transfer Sling	301-463-SZ	\$103.79
Sit to Stand Sling	301-464-SZ	\$90.10
Sit to Stand Buttock Strap	301-465	\$90.10

Padded Spreader Bar Cover

Cover your hard metal spreader bar with a foam pad for patient comfort. Made with durable naugahyde and ½" foam. This pad easily attaches with velcro to spreader "V" bars on patient lifters.
 Color: Tan

Spreader Bar Cover 300-183 \$7.50



Charging Station with Battery

Features:

- › 1, 24v battery on mast with quick release
- › Battery can be replaced immediately with second battery in wall mounted charger
- › UL and CSA certified

Charging Station

- Kit
- Wall Mount only
- Battery only
- Charger only



300-596 \$381.33
 300-732 \$41.78
 300-730 \$164.80
 300-731 \$192.11



Hoyer Partner Retro-Fit Kits

Convert your Original Hoyer Lifter to the New Hoyer Partner Lifter Original Hoyer Lifters

Partner Retro-Fit Boom and Cradle. Converts Original Hoyer Lifter model numbers, C-HLA, P-HLA, E-C-HLA, E-P-C-HLA and C-HLA-RB
 Does NOT include Sling.
 Finish: Apple Red/Black

Retro Fit Kit 300-181 \$325.51



Sling NOT Included

Hoyer Digital Scale

Features:

- › Fits Hoyer Classic and Partner Lifts
- › Digital readouts in pounds up to 600 lbs. or in kilograms up to 272 kg.
- › Maximum weight capacity-600 lbs.
- › Display: Liquid Crystal Digital; Hold and Auto
- › Shut Off: After one minute
- › Power: 9v battery. Battery life: Approximately 3,000 readings

Lifter Scale 300-853 \$819.00



Invacare Digital Scale

New design provides 6" of additional lift range and retro-fit on all Reliant 450/600. Measures weights up to 600 lbs.

Lifter Scale 300-594 \$918.00





Drive Full Body Patient Sling

Features:

- › Designed to support an individual during lift and transfer procedures
- › Slings are reinforced at all points for added safety
- › Material is durable, resists deterioration from exposure to moisture and laundering
- › The edging is soft yet durable with reinforced stitching for safety
- › Slings are constructed with high back section that provides additional support for the head and neck and a padded under thigh section for comfort



Patient Slings

Medium Mesh (compares to Invacare R110)	301-451	\$79.95
Large Mesh (compares to Invacare R111)	301-452	\$79.95
Medium Solid (compares to Invacare R112)	301-453	\$84.95
Large Solid (compares to Invacare R113)	301-454	\$84.95
Extra Large Solid (compares to Invacare R117)	301-450	\$95.95
Medium Mesh with Commode (compares to Invacare R114)	301-455	\$91.75
Large Mesh with Commode (compares to Invacare R115)	301-456	\$91.75
Extra Large Mesh W/Commode (compares to Invacare R116)	301-457	\$91.75



\$107.⁵³

Drive Padded U-Sling Patient Sling

Features:

- › Durable polyester with closed-cell foam padding for added comfort
- › Adaptable to a wide range of shapes, sizes and needs
- › Easily installed and removable

Patient Slings

Small Polyester (compares to Sunrise 70013)	301-458	\$99.95
Medium Polyester (compares to Sunrise 70012)	301-459	\$99.95
Large Polyester (compares to Sunrise 70011)	301-460	\$99.95
Extra Large Polyester (compares to Sunrise 70010)	301-461	\$109.95



Slings for Reliant 450 Lifters



A. Full Body Slings

Medium Mesh	301-224	\$97.34
Large Mesh	301-225	\$97.34
Medium Solid Fabric	301-430	\$97.34
Large Solid Fabric	301-431	\$101.51
Extra Large Solid Fabric	301-432	\$108.47

B. Full Body Slings with Commode Opening

Medium Mesh	301-226	\$104.34
Large Mesh	301-227	\$104.34
Extra Large Mesh	301-228	\$104.34

C. Toileting Sling with Belt Slings

Large Solid Fabric	301-434	\$120.29
--------------------	---------	----------

D. Divided Leg Slings

Medium Solid Fabric	301-427	\$127.93
Large Solid Fabric	301-428	\$127.93
Extra Large Solid Fabric	301-429	\$131.40

A.



B.



C.



D.



Heavy Duty Slings for Reliant Plus

The Full Body Sling is easy to use while transferring a patient from the bed to a wheelchair, toilet or shower-chair or from the floor to a bed. It offers total head and neck support. The padded lower section provides additional under-thigh comfort and support. 600 lb Weight Capacity



Patient Slings

45" x 55"	301-436	\$124.66
45" x 55" with Commode Opening	301-437	\$119.59

Slings for CareGuard Invacare 9805 Hydraulic Lifter with "V" Bar



Patient Slings

A. Mesh Polyester, 40½"x29"	301-223	\$73.70
A. Solid Polyester, 40½"x29"	301-423	\$83.43
B. Mesh Polyester with Commode, 40½"x29"	301-222	\$83.43
B. Solid Polyester with Commode, 40½"x29"	301-422	\$101.39

Chain and Strap

Adjustable Strap	301-521	\$44.17 a set
Sling Chain	301-520	\$41.59 a set

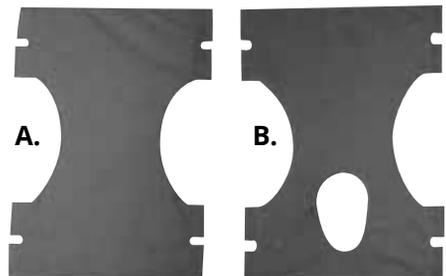

Note: Slings require chains or straps



Nylon Mesh Bath Sling and Nylon Mesh Bath Sling with Headrest

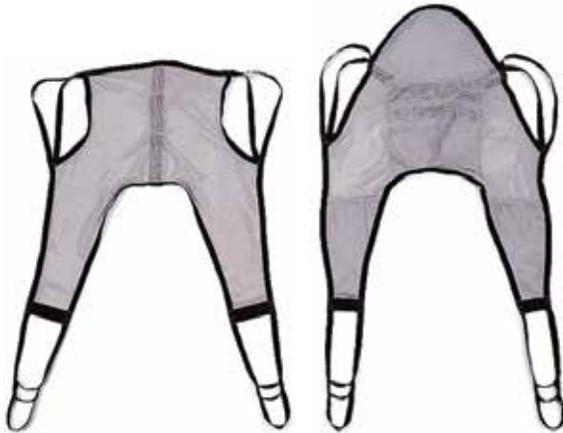

One-Piece Sling with Positioning Strap and One-Piece Commode Sling with Positioning Strap

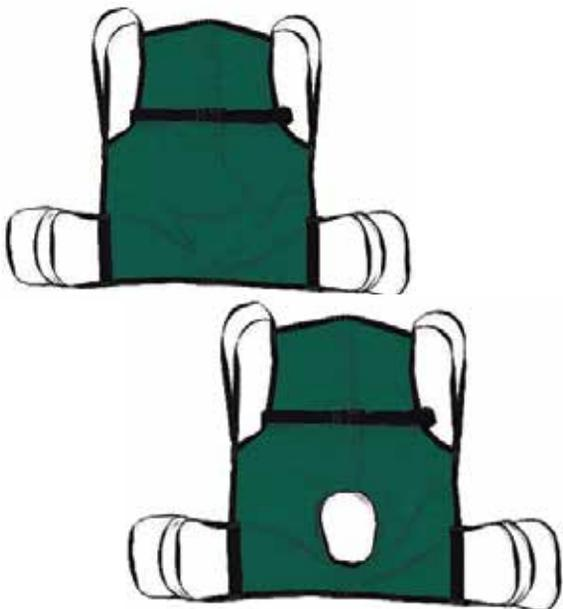

Padded U-Sling and Padded U-Sling with Headrest

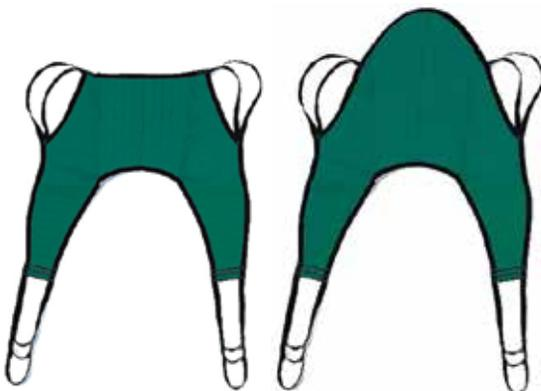

Hoyer® 4-Point Slings

Durable polyester with closed-cell foam padding for comfort. Bathing slings are fast draining and drying nylon mesh. One-piece slings provide easy position adjustment of patient.

Features:

- > 4-point position slings for a secure, safe & comfortable transfer
- > No chains....No more swing or sway
- > Special "U" shape allows easy on and off of patient
- > Semi-rigid design won't bunch up, protecting fragile bones or tissue and giving comfort and security
- > Leg straps unhook and quickly withdraw for toileting
- > Slings fit all Hoyer Lifters with 4-point cradle, reducing sling inventory

Note: Slings are for Hoyer® Lifters with 4-Point attaching cradle ONLY, if you want to use these slings on the Classic Hoyer® Lifter you must convert your lifter with a Retro-Fit Kit on page 117.

Nylon Bathing Sling, Gray

Small	301-609	\$121.95
Medium	301-608	\$121.95
Large	301-607	\$121.95
Extra Large	301-612	\$121.95

Nylon Bathing Sling, Gray

Small with Headrest	301-615	\$131.95
Medium with Headrest	301-614	\$131.95
Large with Headrest	301-613	\$131.95

One-Piece Sling, Green

Small	301-632	\$134.95
Medium	301-631	\$134.95
Large	301-630	\$134.95

One-Piece Sling, Green

Small with Commode	301-635	\$134.95
Medium with Commode	301-634	\$134.95
Large with Commode	301-633	\$134.95

Padded U-Sling, Green

Small	301-625	\$146.95
Medium	301-624	\$146.95
Large	301-623	\$146.95
Extra Large	301-622	\$146.95

Padded U-Sling, Green

Small with Headrest	301-629	\$155.95
Medium with Headrest	301-628	\$155.95
Large with Headrest	301-627	\$155.95
Extra Large with Headrest	301-626	\$155.95

Heavy-Duty Nylon Lifter Sling

600 lb Weight Capacity	301-438	\$179.95
------------------------	----------------	-----------------

Hoyer 2-Point Slings for Classic Hoyer Lifters

One Piece Seat, Low Back

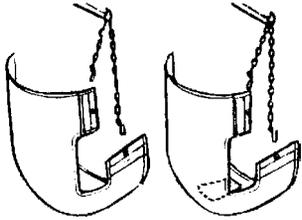

One Piece Low Back Seat

- Without Commode **301-X08 \$80.32**
- With Commode **301-X09 \$80.32**
- Chain Set **301-501 \$65.07 pr.**

One Piece Seat, High Back

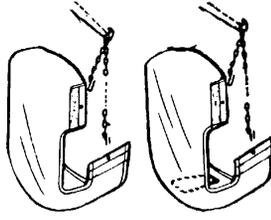

One Piece High Back Seat

- Without Commode **301-X12 \$84.50**
- With Commode **301-X13 \$84.50**
- Chain Set **301-501 \$65.07 pr.**

Comfort Seat

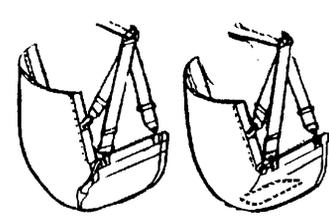

Comfort Seat

- Without Commode **301-X10 \$80.32**
- With Commode **301-X11 \$80.32**
- Web Straps **301-504 \$54.10 pr.**

Replace the "X" in the part number with one of the following numbers: (2) Dacron Mesh or (4) Polydura.

Comfort Seat with Headrest and Wire

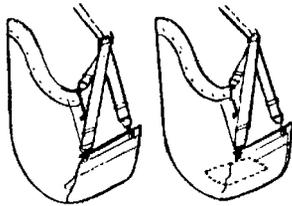

Comfort Seat

- Without Commode **301-X06 \$85.17**
- With Commode **301-X07 \$83.50**
- Web Straps **301-504 \$54.10 pr.**



One Piece Seat, Split Sling

One-Piece split sling with commode opening and wire insert head support. Polydura only. Sling/Straps

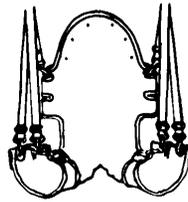

- One Piece Split Sling Seat 301-425 \$146.93**

Replace the "X" in the part number with one of the following numbers: (2) Dacron Mesh or (4) Polydura.

Hoyer 2-Point Slings for Classic Hoyer Lifters

Sling Parts

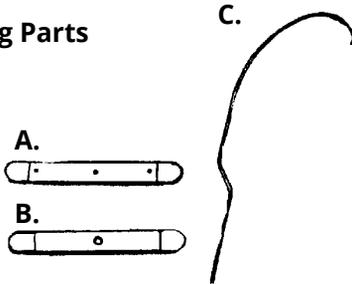

Sling Parts

- A. Wire for Headrest for **301-513 \$10.80**
 301-X06, 301-X07 and 301-425

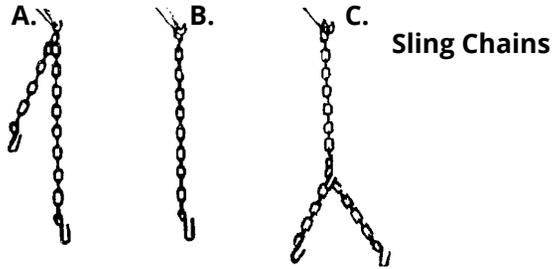

- A. Set of two chains to be used with 301-X08, 301-X09, 301-X12, 301-X13 and 301-423
301-501 \$65.07 a set
- B. Set of two chains to be used with 301-X01 and 301-X02
301-502 \$48.48 a set
- C. Set of two chains to be used with pool lifters
301-503 \$61.88 a set

Seat Straps

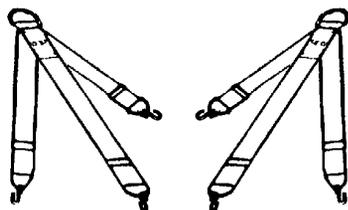

Set of two comfort seat straps to be used with 301-X06, 301-X07, 301-X10, 301-X11, 301-424 and 301-425.

- Seat Straps 301-504 \$54.10 a set**

Spreader Bars

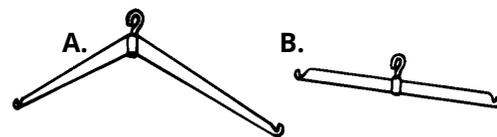

- A. 24" Standard Swivel "V" Bar
 Powder Coated **300-150 \$105.00**
- B. 18" Straight Swivel Bar
 Powder Coated **300-154 \$190.27**

Telescopic Curtain

Pull rod-hung curtains out to a full 90" from wall, push back to an out-of-the-way 51" or flat against wall. Flame-retardant, white vinyl curtain is 72" high. Kit includes wall bracket, telescoping rod, curtain and hooks. Choose White, Blue, Green or Pink curtain.

Curtain, Complete Kit **215-602-CL** **\$129.34**



PVC Privacy Screens

Features:

- > Removable Velcro Panels
- > Mildew Resistant
- > Flame Retardant
- > Durable Light Weight
- > 21"x51" Per Panel
- > 13" Clearance from Base to Bottom of Panel
- > 67" Total Width Expanded (3-Panels)
- > Folded 24"x5"
- > Cleans with Damp Cloth
- > Available in Many Colors

Colors Available: White, Tan, Mint, Light Blue, Mauve, Grey, Black, Red, Yellow, Forest Green, Navy Blue, and Royal Blue

Privacy Screens

- without Casters **200-209-CL** **\$179.00**
- with Casters **200-210-CL** **\$217.83**



Privacy Screens

Flame-retardant white vinyl panels wash easily. White powder coated steel frame. Measure 27" x 55" per panel and. This unit has a wide body base of 22" x 27". Without casters is 15½" from floor to bottom of screen with an overall height of 67". With casters is 17½" from floor to bottom of screen with an overall height of 69". Choose White, Blue, Green or Pink curtain.

Privacy Screens

- without Casters **215-600-CL** **\$131.09**
- with Casters **215-601-CL** **\$135.99**



Folding Panel Screens

Features:

- > Open to full width without zig-zagging
- > Conserves floor space
- > ¾" anodized aluminum tubing
- > Flame retardant bacteriostatic 6-mil white vinyl
- > Each panel adds 20" to width and ¾" to folded depth
- > Overall Height: 69"
- > Panel Width: 20"

Folding Screen

- 3 Panel Screen **215-606** **\$124.44**
- 4 Panel Screen **215-607** **\$159.99**
- 5 Panel Screen **215-608** **\$154.74**



A2 Anti-Microbial Orbitz Cubicle Curtains

All Cubicle Curtains are manufactured with inherently fire retardant (IFR) fabric; the fire retardancy lasts through the life of the curtain. The top FR nylon mesh with 1½" woven, snag free header, combined with our #2 grommet, provides superior durability and long lasting performance. We warrant our labor and materials for one year to be free of defects under normal handling conditions and when care instructions are complied with fully. Curtains are shipped within 10 business days of your order.

**For curtains below 90" in height, the mesh will be 20".
 For curtains 90" and above, the mesh is 28."**

Colors: 01-Cabernet, 02-Ecru, 03-Eggnog, 04-Federal, 05-Garland, 06-Kiwi, 07-Sandstone, 08-Zephyr.

Curtains are available without mesh, please call Customer Service for pricing.



Wholesale (catalog) Curtains Part Number and Pricing Guide

Build Your Own Part Number	Category	Width	Height	Pattern	Color
Sample	A2	072	084	A	05

A2-072084A05

Horizontal Width

Vertical Height (Height)

	72"(68")	90"(84")	108"(102")	126"(120")	144"(138")	162"(155")	180"(173")	198"(191")	216"(209")	234"(225")	252"(243")	270"(261")
84"	\$84.00	\$114.00	\$124.00	\$144.00	\$164.00	\$194.00	\$214.00	\$234.00	\$264.00	\$284.00	\$304.00	\$324.00
90"	\$89.00	\$120.00	\$130.00	\$149.00	\$169.00	\$199.00	\$219.00	\$239.00	\$269.00	\$289.00	\$309.00	\$329.00
96"	\$94.00	\$124.00	\$134.00	\$154.00	\$174.00	\$204.00	\$224.00	\$244.00	\$274.00	\$294.00	\$314.00	\$334.00
102"	\$104.00	\$134.00	\$144.00	\$164.00	\$184.00	\$214.00	\$234.00	\$254.00	\$284.00	\$304.00	\$324.00	\$344.00
108"	\$114.00	\$145.00	\$154.00	\$174.00	\$194.00	\$224.00	\$244.00	\$264.00	\$294.00	\$314.00	\$334.00	\$354.00
120"	\$119.00	\$150.00	\$159.00	\$179.00	\$199.00	\$229.00	\$249.00	\$269.00	\$299.00	\$319.00	\$339.00	\$359.00

Anti-Microbial Orbitz Colors:

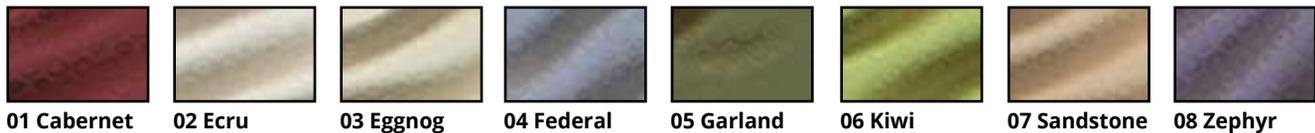

All Cubicle Curtain sizes also come in many different patterns and colors. Some are shown above (please note other colors and patterns may have an up charge). To see the full selection of colors and patterns please visit www.ocelco.com.

For other available patterns, please visit our website at www.Ocelco.com or call our customer service at 1.800.328.5343

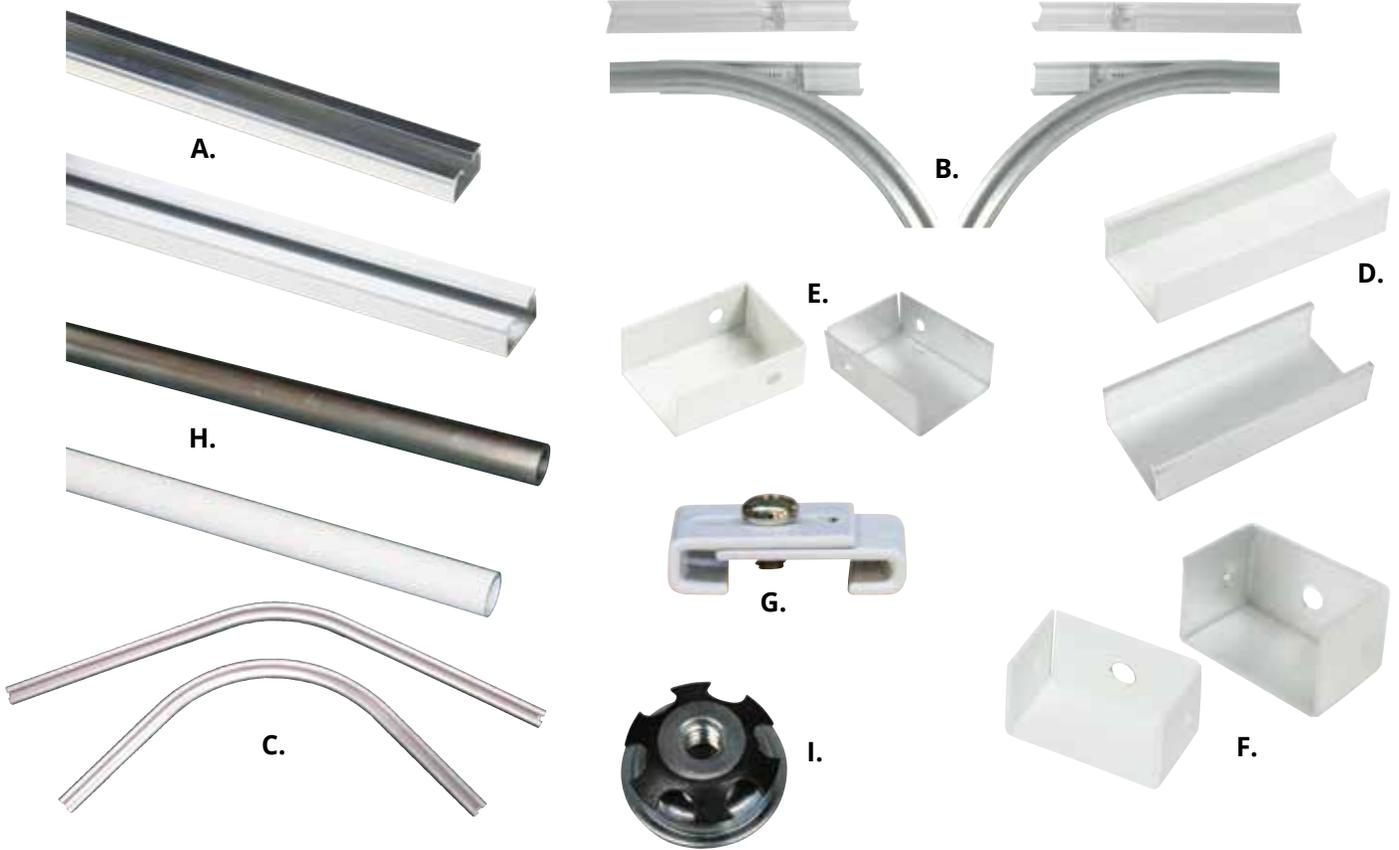

- A. Channel** 16 gauge extruded aluminum. Sold in 8 foot lengths. Approximately $\frac{7}{8}$ "x1 $\frac{1}{4}$ ".
 Silver Aluminum **215-400-S** **\$3.80/ft** White **215-400-W** **\$4.45/ft**
- B. Joining Sleeve** For suspended installations. Connects straight section of one track with curved section of adjoining track. Right and left are determined by looking up at the ceiling.
 Silver Right **215-303-S** **\$21.41** White Right **215-303-W** **\$22.58**
 Silver Left **215-304-S** **\$21.41** White Left **215-304-W** **\$22.58**
- C. Curves** Channel bent to 12" radius. 90° and 45° one bend curves standard.
 2'x2', 90° Silver **215-505-S** **\$33.00** 2'x2', 90° White **215-505-W** **\$37.00**
 2'x2', 45° Silver **215-506-S** **\$33.00** 2'x2', 90° White **215-506-W** **\$37.00**
- D. Splicing Clamp** Anodized sleeve for joining and extending track sections assuring proper alignment of track channels. 3"
 Silver **215-504-S** **\$2.14** White **215-504-W** **\$2.70**
- E. End Stop** Prevents carriers from slipping out of end of track.
 Silver **215-501-S** **\$2.14** White **215-501-W** **\$2.70**
- F. Snap Out Fitting** Permits easy replacement of carriers.
 Silver **215-503-S** **\$2.14** White **215-503-W** **\$2.70**
- G. Ceiling Clip** Recommended spacing: 2" to 6". For fastening track channel to T-bar on drop ceiling. Color: Off White.
215-109 **\$5.45**
- H. Suspension Tube** Recommended Spacing 6". Made from 1" O.D. hollow anodized aluminum tubing. Sold in 8 foot lengths.
 Silver **215-401-S** **\$3.80/ft** White **215-401-W** **\$3.95/ft**
- I. Screw Insert** Inserts in end of suspension tube. Holds suspension tube to track channel. One needed for each tube.
 Silver Aluminum **215-402** **\$ 1.07**

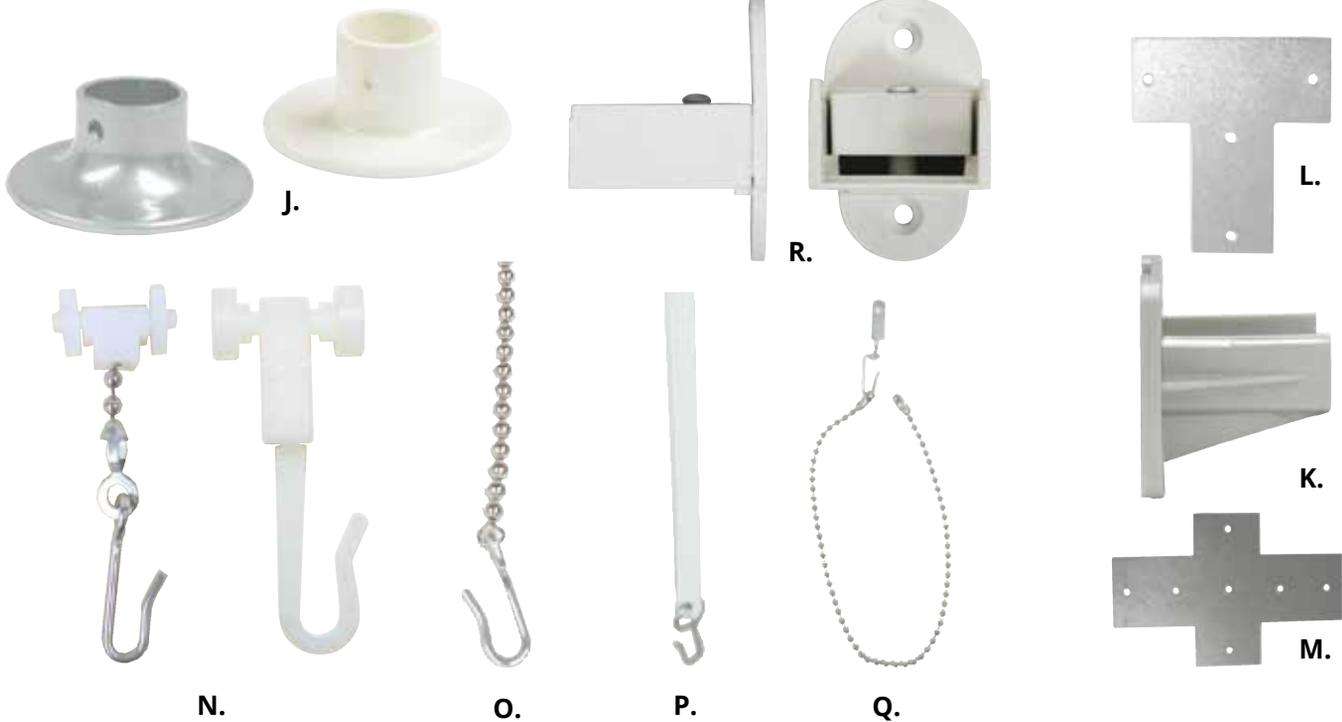

J. Ceiling Flange Constructed of heavy-duty aluminum. For connecting suspension tube to ceiling. Fasteners required to attach flange to ceiling. Hole in side for screwing to suspension tube.

Silver	215-300-S	\$16.45
White	215-300-W	\$7.50

K. Nylon Wall Bracket For fastening track channel to wall in suspended installations.

Silver	215-301	\$14.20
---------------	----------------	----------------

L. T-Bracket For suspended installations. Joins 2 tracks into 90° connection.

Silver	215-107	\$11.56
---------------	----------------	----------------

M. Cross Bracket For suspended installation. Center piece subdivides 4 bed areas.

Silver	215-108	\$11.56
---------------	----------------	----------------

N. Single Carrier Carrier spacing: 6". Block supported from 2 nylon wheels. Plated swivel and curtain hook for effortless and quiet curtain movement. Carrier width: approximately ½".

215-500	\$1.89
----------------	---------------

N. Single Breakaway Carrier Carrier spacing: 6". Nylon block supported from 2 nylon wheels. Break weight is 15-20 lbs

215-502	\$1.89
----------------	---------------

O. Drop Chain Extension chain 18" long constructed of nickel plated steel. Used when ventilation space is required and mesh top is not feasible.

215-103	\$4.33
----------------	---------------

P. PVC Drop Strip Extension strip 18" long constructed of PVC. Hole at top slips over hook on carrier. Plated hook at bottom for attaching curtain. Used in place of mesh for ventilation at top of curtain.

215-104	\$3.13
----------------	---------------

Q. Curtain Tie-Back Chain constructed of nickel plated brass prevents billowing of curtain from track end.

215-102	\$6.74
----------------	---------------

R. Wall Bracket Wall Bracket Assembly for Curtain Tracking, 2-Piece White Plastic

White	215-404	\$9.33
--------------	----------------	---------------

Mechanical Analog Bath Scale



Features:

- › Steel base and platform
- › Large 6½ easy-to-read dial
- › Oversized platform
- › Non-slip mat
- › Pounds and kilograms
- › Black on white

Dial Scale 304-204 \$72.86

Health o meter
Professional

Digital Bath Scale



Features:

- › 400 lb capacity
- › Extra large display 5.5" x 5"
- › Oversized platform
- › Impact resistant tempered glass platform
- › Pounds and kilograms

Digital Scale 304-211 \$40.83



Manual Physician Scale

Features:

- › Rotating poise bars for dual reading of pounds and kilograms.
- › Factory calibrated to ensure accuracy
- › Works with wheelchair attachment

Physician Scale 304-208 \$219.74

Health o meter
Professional



Health o meter
Professional

Manual Physician Scale w/Measuring Rod

Features:

- › Rotating poise bars for dual reading of pounds and kilograms.
- › Dual-read height rod range 24" to 84"
- › Factory calibrated to ensure accuracy
- › Includes 100 lb counterweight to increase capacity to 450 lbs

Physician Scale 304-200 \$234.21



Digital Physician Scale

Features:

- › Weight Capacity: 500 lb / 227 kg
- › Wheels and handle for maximum portability

Physician Scale 304-318 \$530.86

Health o meter
Professional



Digital Physician Scale w/Measuring Rod

Features:

- › Weight Capacity: 500 lb / 227 kg
- › Wheels and handle for maximum portability

Physician Scale 304-317 \$618.52

Health o meter
Professional



Manual Chair Scale

Feaures:

- › Seat attaches to 4 precision tuned load cells to eliminate variations in displayed weights
- › Movable arms and folding footrest for easy access and patient comfort
- › Weight Capacity: 350 lbs.

Chair Scale 304-201 \$522.22

Health o meter
Professional



SHIPS BY TRUCK



SHIPS BY TRUCK

Digital Chair Scales

Features:

- › Motion-sensing weighing technology
- › Large 1" LCD Display
- › Uses 6 C-cell batteries or 120V AC adapter power supply, adapter included
- › Movable arms for easy access
- › Weight Capacity: 600 lbs.

Chair Scale 304-301 \$1211.90

Health o meter
Professional

Digital 2-piece Platform Scale

Features:

- › 9' cord allows easy, safe positioning of the display on the wall or on a table (enclosed table-top bracket)
- › ½" LCD displays weight in lb & oz or kg
- › Features zero setting
- › Operates on 1 9V battery (included) and 120V AC adapter

Platform Scale **304-310** **\$251.32**

Health o meter
 Professional



Pro Plus Electronic Handrail Scale

Features:

- › High capacity scale with wraparound handrail for safety and stability
- › Customizable 1" backlit LCD displays in fractions and decimals
- › Oversized 26"x24¼" platform with wheels for mobility.
- › Includes 1 USB and 2 serial ports
- › 6 D-cell batteries (not included), 120V AC adapter (included)
- › 180° swivel head

Handrail Scale **304-313** **\$1,885.00**

\$1,459.00

Health o meter
 Professional



Bariatric Platform Scale

Features:

- › Heavy-duty steel base and Easy-Grip handrail for patient stability
- › 1" LCD display
- › 19½" x 19½" platform with wheels for mobility
- › 6 C-Cell batteries (not included), 120V AC adapter (included)

Platform Scale **304-311** **\$1,319.05**

Health o meter
 Professional



\$1,639.00

Health o meter
 Professional

Pro Plus™ Electronic Wheelchair Scale

Features:

- › Ramp attaches to either side
- › Customizable 1" backlit LCD displays in fractions and decimals
- › Oversized 28½"x29¾" platform with wheels for mobility (non-folding)
- › Oversized 32"x37" platform with wheels for mobility (folding)
- › Includes 1 USB and 2 serial ports
- › Keypad entry, BMI, manual tare,
- › 6 D-cell batteries (not included) 120V AC adapter (included)
- › 180° swivel head for side read

Wheelchair Scale

Non-Folding **304-315** **\$2007.00**
 Folding **304-314** **\$2026.00**



Non-Folding

Folding



Single Hampers



Double Hampers



Triple Bin Hamper



Standard Linen Hampers

Features:

- › Wire hangers and mesh bag comes standard
- › Front panel opens for easy removal
- › Mesh bags removable for easy cleaning



SHIPS BY TRUCK

All 2 and 3-Bin Hampers ship by Truck.

Standard Hampers with 3" Heavy-Duty Casters

1 Bin, 33 Gallon Mesh Bag	312-401-CL	\$126.21
1 Bin, 33 Gallon Mesh Bag, with Foot Pedal	312-400-CL	\$133.75
1 Bin, 55 Gallon Mesh Bag	312-407-CL	\$142.50
1 Bin, 55 Gallon Mesh Bag, with Foot Pedal	312-406-CL	\$143.75
2 Bins, 33 Gallon Mesh Bag	312-403-CL	\$188.75
2 Bins, 33 Gallon Mesh Bag, with Foot Pedal	312-402-CL	\$222.50
2 Bins, 55 Gallon Mesh Bag	312-409-CL	\$212.50
2 Bins, 55 Gallon Mesh Bag, with Foot Pedal	312-408-CL	\$246.25
3 Bins, 33 Gallon Mesh Bag	312-405-CL	\$290.00
3 Bins, 33 Gallon Mesh Bag, with Foot Pedal	312-404-CL	\$326.25
3 Bins, 55 Gallon Mesh Bag	312-411-CL	\$317.50
3 Bins, 55 Gallon Mesh Bag, with Foot Pedal	312-410-CL	\$373.75

Specify color from page 158

Options

Inner Liner, White, 30"x40", for 33 Gallon	312-413	\$11.08
Inner Liner, White, 40"x40", for 55 Gallon	312-414	\$14.83
Tricot Leak Resistant Laundry Bag for 33 Gallon Std Hampers, Blue or White	312-327-CL	\$25.17
Tricot Leak Resistant Laundry Bag for 55 Gallon Jumbo Hampers, Blue or White	312-335-CL	\$27.32
Zipper Option for Mesh Outer Bag	312-328	\$3.33
Vacuum Formed Lid for 55 Gallon Hamper	312-329	\$37.67

9 Bushel Laundry Cart

Features:

- › 9 bushel capacity
- › Fits under washer and dryer
- › 3" Extra wide casters
- › Removable and washable liner
- › 30" Long x 30" Wide x 26" High

Laundry Cart

312-412-CL \$128.93



Echo Line Linen Carts



Specifications:

Overall Length: 27"
Overall Width: 20"
Overall Height: 51½"
Shelf Size: 20"x25"
Between Shelves: 14½"
Capacity per Shelf: 60 lbs.

Specifications:

Overall Length: 36"
Overall Width: 20"
Overall Height: 51½"
Shelf Size: 20"x32"
Between Shelves: 14½"
Capacity per Shelf: 75 lbs.

Specifications:

Overall Length: 46¾"
Overall Width: 20"
Overall Height: 65"
Shelf Size: 20"x45"
Between Shelves: 16"
Capacity per Shelf: 100 lbs.

Linen Cart 312-617-CL \$162.76

Specify mesh or solid vinyl material
Specify color from page 158

Linen Cart 312-618-CL \$180.95

Specify mesh or solid vinyl material
Specify color from page 158

Linen Cart 312-619-CL \$236.70

Specify mesh or solid vinyl material
Specify color from page 158

Full Quality Linen Carts

All carts come with push bar at both ends and removable shelves for easier cleaning and maximum storage area. Carts come with 5" x 1¼" extra wide heavy duty caster (2 locking) and mesh cover standard.



Linen Carts with 16" Between Shelves

- 2 Shelves, 24"x20" Shelf Size **312-415-CL \$187.50**
- 2 Shelves, 32"x20" Shelf Size **312-418-CL \$201.25**
- 3 Shelves, 24"x20" Shelf Size **312-416-CL \$231.25**
- 3 Shelves, 32"x20" Shelf Size **312-419-CL \$281.25**
- 4 Shelves, 24"x20" Shelf Size **312-417-CL \$276.25**
- 4 Shelves, 32"x20" Shelf Size **312-420-CL \$337.50**

Linen Carts with 16" Between Shelves

- 2 Shelves, 42"x20" Shelf Size **312-421-CL \$260.00**
- 2 Shelves, 48"x20" Shelf Size **312-424-CL \$251.25**
- 3 Shelves, 42"x20" Shelf Size **312-422-CL \$328.75**
- 3 Shelves, 48"x20" Shelf Size **312-425-CL \$347.50**
- 4 Shelves, 42"x20" Shelf Size **312-423-CL \$391.25**
- 4 Shelves, 48"x20" Shelf Size **312-426-CL \$404.63**



Call for More Options & Sizes
Specify color from page 158



3 Shelf Multi-Purpose Cart

Specifications:

Overall Length:	31½"
Overall Height:	37"
Overall Width:	24"
Between Shelves:	14½"
Carrying Capacity:	75 lbs.

Multi-Purpose Cart

22" x 20" Shelves, 12.5" Spacing	312-429	\$185.00
32" x 16" Shelves, 14.5" Spacing	312-430	\$205.00



Emergency Cart

E series oxygen holder positioned within frame. Rail secures suction machine. 2 recessed shelves for secure storage. (Oxygen bottle and suction machine not included)

Emergency Cart

Cart	312-428	\$247.50
Optional Cover (complete unit)	312-431-CL	\$36.67



Refreshment Cart

48 Qt. ice chest with drain and ice scoop with holder. 3" extra wide casters. Canopy cart has 4" casters and a serving shelf plus three storage shelves.



Refreshment Cart

with Skirt cover	312-427-CL	\$231.25
Canopy Ice Cart	312-444-CL	\$277.50

Bin Cart with Shelves

Specifications:

Overall Length: 52"
 Overall Width: 21.5"
 Overall Height: 64.25"



Bin Cart with Shelves **312-432-CL \$363.75**
 Specify color from page 158

Bin Carts

Specifications:

Overall Length: 52"
 Overall Width: 21.5"
 Overall Height: 64.25"



Bin Carts
 16 Bins **312-433-CL \$459.75**
 24 Bins **312-434-CL \$554.17**
 Specify color from page 158

Other combinations available

Chart Rack Carts

Binders not included



Chart Rack Cart

- Holds 10 Charts with Spine less than 2¾"
- Holds 20 Charts with Spine less than 2¾"
- Holds 30 Charts with Spine less than 2¾"
- Holds 40 Charts with Spine less than 2¾"
- Holds 10 Charts with Spine 2¾" to 4"
- Holds 20 Charts with Spine 2¾" to 4"
- Holds 30 Charts with Spine 2¾" to 4"
- Holds 40 Charts with Spine 2¾" to 4"

- 313-530-SM \$143.75**
- 313-531-SM \$187.50**
- 313-532-SM \$211.75**
- 313-533-SM \$228.75**
- 313-530-LG \$143.75**
- 313-531-LG \$187.50**
- 313-532-LG \$211.25**
- 313-533-LG \$288.75**





Dispos-A-Scope

Dispos-A-Scope nurse stethoscopes feature a plastic binaural and ultra sensitive plastic chest piece with remarkable acoustical performance. Designed for single patient use to prevent cross contamination in infectious areas.

Dispos-A-Scope **\$1.59**
 30" Blue **260-796**
 30" Yellow **260-797**



Single Head

Proscope Nurse Single or Dual Head Stethoscope

The broad variety of colors offer many choices of departmental coding as well as individual user preference. Each stethoscope features a non-chill diaphragm, lightweight aluminum chest piece, 22" Y-tubing, and a pair of mushroom ear tips. Overall stethoscope length is 32".

Colors:

Black(46), Burgundy(27), Hunter Green(51), Grey(44), Green(50), Gold(36), Yellow(30), Lt Blue(64),Lavender(15), Magenta(25), Navy(18). Orchid(16), Pink(24), Purple(10), Red(20), Royal Blue(67), Teal(53), White(94)
 Neon Colors- Neon Pink(02), Neon Orange(07)

Proscope Stethoscope

Single Head **260-1CL \$3.83**
 Dual Head **260-2CL \$5.33**

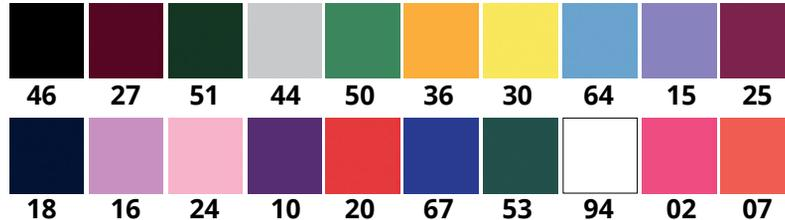

Legacy Sprague Rappaport-Type Stethoscope

The most popular stethoscope on the market today, it offers unlimited flexibility while maintaining superior acoustic qualities. The interchangeable chest piece accessories allow for custom user design. Heavy walled 22" tubing blocks out extraneous sounds even in the noisiest conditions. Comes complete with accessory pouch and instructions. Overall stethoscope length is 32".

Colors:

Black(46), Burgundy(27), Hunter Green(51), Gray(44), Green(50), Blue(67), Yellow(30), Teal(53), Lavender(15), Magenta(25), Navy(18), Purple(10), Red(20), Orange(70)

Legacy Stethoscope **260-5CL \$10.33**

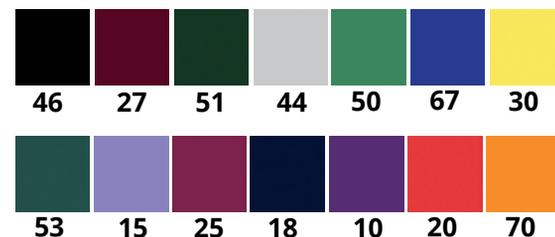

Teaching/Training Stethoscope

The Training Stethoscope is designed for multifunction teaching applications. The dual head design offers the necessary flexibility to use this scope in all clinical and educational conditions. Comes complete with two binaurals, two pieces of Y-tubing, and an extension tube.

Teaching/Training Stethoscope **260-798** **\$12.08**



Signature Series Stainless Steel Stethoscopes

The stainless steel stethoscope offer unsurpassed quality and value. All models feature deluxe stainless steel chest piece and stainless steel dual inner-spring binaural. The color coordinated non-chill ring and Uni-Fit™ diaphragm retaining ring provide excellent patient comfort. Includes two extra sets of ear tips and one extra diaphragm.

Infant Colors: Black(46), Grey(44), Pink(24), Lt Blue (64)
 Adult Colors: Blue(67), Black(46), Gray(44), Burgundy(27), Hunter Green(51)
 Pediatric Colors: Black(46), Gray(44), Lt Blue(64), Pink(24)

Signature Series	\$38.08	Adscope Pediatric	\$57.87
Infant	261-3CL	Pediatric	261-2CL
Adult	261-1CL		



Signature Cardiology Stethoscopes

The Signature stainless steel cardiology stethoscope features a dual inner-spring stainless steel binaural and deep cone shaped stainless steel bell for excellent acoustic sensitivity. The Uni-Fit™ diaphragm retaining ring insures proper diaphragm fit for optimum sound transmission. The Signature Cardiology Stethoscope is packaged in a foam lined case with two extra sets of ear tips.

Signature Cardiology **261-0CL** **\$75.33**



Clear Sound Stethoscope

Ultra-sensitive acoustics for use through bandages or clothing. Accurate assessment through up to 10 layers of terry cloth towel! Head manufactured from high impact crack resistant modern plastic. Latex free tubing. Limited Lifetime Warranty.

Clear Sound Stethoscopes

Clear Sound Stethoscopes	260-3CL	\$28.25
Clear Sound Heart Stethoscopes	260-6CL	\$28.25

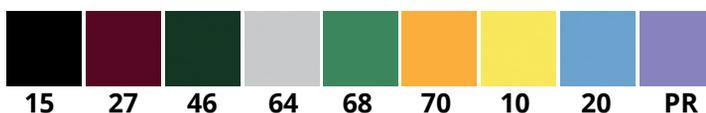

Clear Sound Heart Stethoscope



Parts for Spectrum Stethoscopes

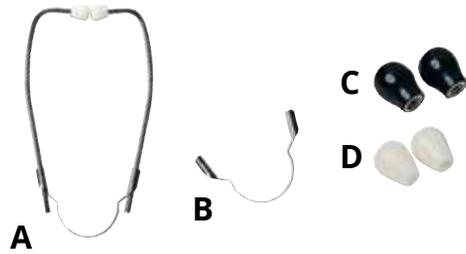

Binaural

- A. 1/4" Lightweight Chrome Plated Brass **270-120 \$3.11**
- B. 1/4" Chrome Binaural Spring **271-905 \$2.19**

Ear tips

- C. 1/4" Soft Black Rubber Mushroom **270-222 \$0.71 a pair**
- D. 1/4" White Plastic **270-221 \$1.13 a pair**

Chest piece

- E. Complete Single Head, Silver **271-498 \$3.93**
- F. Complete Dual Head, Silver **271-598 \$4.57**
- G. Diaphragm **271-911 \$1.13**

Tubing

- H.22" PVC "Y" Tubing, Specify Color **271-OCL \$1.56**
- Black(46), Burgundy(27), Hunter Green(51), Grey(44), Green(50), Gold(36), Yellow(30), Lt Blue(64), Lavender(15),Magenta(25), Navy(18), Orchid(16), Pink(24), Purple(10), Red(20), Royal Blue(67), Teal(53), White(94), Neon Colors- Neon Pink(02), Neon Orange(07), Neon Yellow(03)

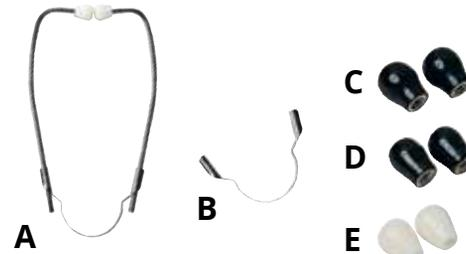
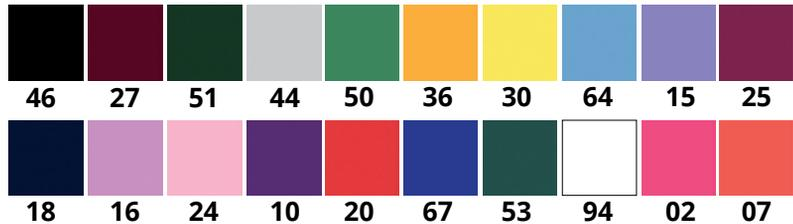

Binaural

- A. 3/8" Standard with Soft Clear Silicone Tip **270-110 \$4.60**
- B. 3/8" Chrome Binaural Spring **271-901 \$2.73**

Ear tips

- C. 3/8" Soft Black Rubber Mushroom **270-232 \$1.24 a pair**
- D. 3/8" Black Plastic **270-212 \$1.13 a pair**
- E. 3/8" Soft Clear Silicone **270-233 \$0.74 a pair**

Chest piece

- F. Complete Sprague, Silver **271-698 \$12.00**
- Small Diaphragm **271-908 \$1.40**
- G.Large Diaphragm **271-906 \$1.33**

Accessories

- Cap for End of Sprague Tube **271-902 \$0.74**
- Accessory Kit (3 bells, extra ear tips and 2 diaphragms) **271-904 \$9.48**

Tubing

- H.22" Sprague, Specify Color **271-3CL \$7.12 a pair**
- Black(46), Burgundy(27), Hunter Green(51), Grey(44), Green(50), Lavender(15), Magenta(25), Navy(18), Purple(10), Red(20), Blue(67), Teal(53), Orange(70), Yellow(30)

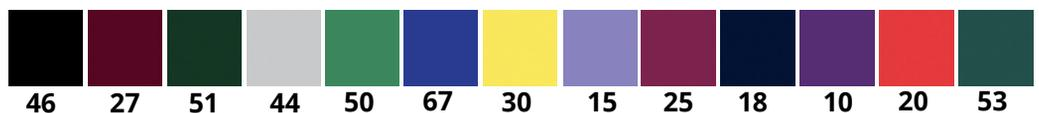

All 3M™ Littmann™ Stethoscopes

Large Ear tips (Pair)

Soft-Sealing, Snap Tight

Black, Littmann # 37811

Gray, Littmann # 37812

Firm, Snap Tight

Gray, Littmann # 37808

Small Ear tips (Pair)

Soft-Sealing, Snap Tight

Black, Littmann # 37809

Gray, Littmann # 37810

Firm, Snap Tight

Gray, Littmann # 36539

\$19.76
261-584
261-585
\$8.96
261-587
\$19.76
261-591
261-592
\$12.10
261-594



Note:

Littmann Stethoscopes manufactured prior to early 1994 use threaded ear tips. All others use snap-tight. Threaded and Snap-tight are not interchangeable.

3M™ Littmann™ Electronic 2000 and 4000

Diaphragm

with Logo, Littmann # 36560

Small, Snap-on Rim

Black, Littmann # 36550

\$7.44
261-596
\$8.38
261-598

3M™ Littmann™ Master Cardiology

Tunable Diaphragm/Rim Assembly

Black, Littmann # 36554

Gray, Littmann # 36555

\$15.82
261-599
261-600

3M™ Littmann™ Cardiology III

Nonchill Bell Sleeve

Black, Littmann # 36570

Gray, Littmann # 36571

Large Snap-on Rim

Black, Littmann # 36548

Gray, Littmann # 36549

Small Snap-on Rim

Black, Littmann # 36550

Gray, Littmann # 36551

Tunable Diaphragm/Rim Assembly

Large, Black, Littmann # 36556

Large, Gray, Littmann # 36557

Small, Black, Littmann # 36572

Small, Gray, Littmann # 36573

\$10.24
261-601
261-602
\$8.38
261-603
261-604
\$8.38
261-598
261-606
\$14.88
261-607
261-608
261-609
261-610

3M™ Littmann™ Select

Tunable Diaphragm/Rim Assembly

Large, Black, Littmann # 36556

Large, Gray, Littmann # 36557

\$14.88

261-607

261-608

3M™ Littmann™ Master Classic II

Tunable Diaphragm/Rim Assembly

Large, Black, Littmann # 36556

Large, Gray, Littmann # 36557

\$14.88

261-607

261-608

3M™ Littmann™ Classic II Pediatric

Nonchill Bell Sleeve

Black, Littmann # 36546

Gray, Littmann # 36568

Small Snap-on Rim

Black, Littmann # 36550

Gray, Littmann # 36551

Diaphragm with Logo

Black, Littmann # 36560

\$7.90
261-613
261-614
\$8.38
261-598
261-606
\$7.44
261-596

3M™ Littmann™ Classic II Infant

Nonchill Bell Sleeve

Black, Littmann # 36547

Gray, Littmann # 36569

Infant Snap-on Rim

Black, Littmann # 36552

Gray, Littmann # 36553

Diaphragm with Logo

Black, Littmann # 36561

\$7.90
261-615
261-616
\$8.38
261-617
261-618
\$7.44
261-597

3M™ Littmann™ Classic II S.E.

Nonchill Bell Sleeve

Black, Littmann # 36544

Gray, Littmann # 36545

Large Snap-on Rim

Black, Littmann # 36548

Gray, Littmann # 36549

Tunable Diaphragm/Rim Assembly

Large, Black, Littmann # 36556

Large, Gray, Littmann # 36557

\$7.90
261-611
261-612
\$8.38
261-603
261-604
\$14.88
261-607
261-608

"Benjamin Bear" Blood Pressure Kits



"Benjamin" Bear kid-friendly blood pressure kits feature the same quality and precision of adult sized units, but use fun, colorful graphics to create a calming distraction for children. Kits include a washable nylon cuff in child or infant sizes, a latex-free bladder, a bear shaped bulb, high quality embroidered carrying case and an easy-to-read gauge with a Ten Year Calibration Warranty. Bulbs and cuffs are available separately.

Benjamin Bear

Infant Blood Pressure Kit	272-300	\$49.92
Child Blood Pressure Kit	272-301	\$49.92
Infant Cuff	272-302	\$18.00
Child Cuff	272-303	\$18.00
Bear Bulb	272-304	\$7.90



Pro's Combo II Aneroid Kit



A professional kit that combines our best selling aneroid, with an optional stethoscope in a color coordinated premium nylon case

Features:

Contemporary black enamel 300mmHg no-pin stop manometer, Adcuff™ calibrated nylon cuff with proprietary Size Guide™ marking system prevents mis-cuffing, Latex inflation bladder and bulb, Chrome-plated deflation valve, Extra large, color-matched, dual pocket carry case, measures 10" x 6" x 3"

Colors:

Black(46), Burgundy(27), Dark Green(51), Magenta(25), Navy(18), Orange(70), Purple(10), Red(20), Royal Blue(68), Teal(53)

Pro's Combo II **267-1CL \$43.43**



A professional kit that combines our best selling aneroid, with an optional stethoscope in a color coordinated premium nylon case

Features:

Contemporary black enamel 300mmHg no-pin stop manometer, Adcuff™ calibrated nylon cuff with proprietary Size Guide™ marking system prevents mis-cuffing, Latex-Free inflation bladder and bulb, Chrome-plated deflation valve, Extra large, color-matched, dual pocket carry case, measures 10" x 6" x 3"

Colors:

Black(46), Burgundy(27), Dark Green(51), Magenta(25), Navy(18), Orange(70), Purple(10), Red(20), Royal Blue(68), Teal(53)

Latex-Free Pro's combo II **267-0CL \$43.43**



Caliber Series Aneroid Sphygmomanometers

The Caliber aneroid sphygmomanometers are designed for many years of rough service in the hospital and nursing home, as well as the EMT field. These units are backed by a Twenty Year Calibration Warranty. The Caliber Series is only available in a calibrated blue nylon cuff and a deluxe air release valve. Comes with matching blue aneroid gauge in the most frequently requested cuff sizes.

Caliber Series

Infant	262-567	\$31.73
Child	262-467	\$32.08
Adult	262-367	\$32.08
Large Adult	262-267	\$35.33
Thigh	262-167	\$38.25



Prosphyg 760 Series Sphygmomanometers

Contemporary black enamel 300mmHg no-pin stop manometer, provides day-in, day-out dependability. Adcuff™ nylon cuff with ADC's proprietary Size Guide™ marking system, prevents mis-cuffing. Dip molded latex inflation bladder withstands heavy use. Chrome-plated brass air release valve. Leatherette carrying case with durable nylon zipper.

Prosphyg Series

Infant Black	263-546	\$36.97
Child Black	263-446	\$36.97
Adult	263-3CL	\$36.97
Large Adult Black	263-246	\$45.05
Thigh Black	263-146	\$38.17



Each unit features a black, calibrated nylon cuff and EZView™ luminescent dial. The entire inflation system (bulb, tubing and bladder) is manufactured using the finest neoprene available. The gauge is backed by a Lifetime Calibration Warranty and the inflation system is covered by a Five Year Warranty.

Latex-Free Legacy Series

Infant Black	267-646	\$35.18
Child Black	267-746	\$36.97
Adult Black	267-546	\$36.97
Large Adult Black	267-846	\$45.05
Thigh Black	267-946	\$51.10



Diagnostix Palm Style Blood Pressure Unit

Aneroid sphygmomanometer will offer the practitioner many years of unequalled service. The deluxe chrome palm aneroid gauge is backed by a Lifetime Calibration Warranty, in addition to a Three Year Warranty on the component parts. Deluxe calibrated nylon cuff and heavy-duty latex bladder will provide many years of uninterrupted service. Complete unit is packed in a carrying case.

Colors:

Black(46), Burgundy(27), Dark Green(51), Grey(44), Green(50), Magenta(25), Navy(18), Orange(70), Purple(10), Red(20), Royal Blue(67), Teal(53)

Diagnostix

Adult	266-3CL	\$86.89
-------	----------------	----------------

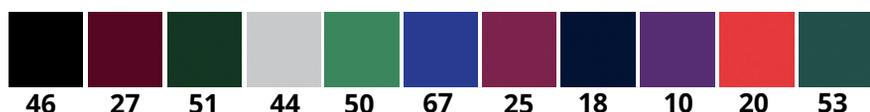



Pro's Combo II Dual Head Combination Kit

Each stethoscope features a chrome plated brass binaural, lightweight anodized aluminum chest piece, 22" vinyl "Y" tubing, spare diaphragm and a pair of mushroom ear tips.

Colors: Black(46), Burgundy(27), Dark Green(51), Magenta(25), Navy(18), Orange(70), Purple(10), Red(20), Royal Blue(68), Teal(53)

Pro's Combo II 267-3CL \$48.62

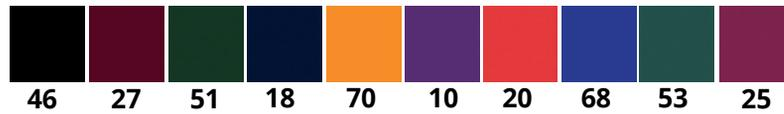

Match Mates® Sprague Rappaport-Type Kit

Outstanding quality and versatility come together with our Match Mates Aneroid Sphygmomanometer and Sprague Rappaport-Type Stethoscope, the most popular style of stethoscope today. The stethoscope includes 5 interchangeable chest pieces: 3 Bells (adult, medium and infant) and 2 diaphragms (small and Large) for custom user design, plus 3 different types of ear tips for maximum comfort.

Colors: Black(46), Orange(70), Red(20) Magenta(25), Teal(53), Purple(10), Royal Blue(68), Navy(18), Hunter Green(51), Burgundy(27)

Match Mate 267-4CL \$49.75

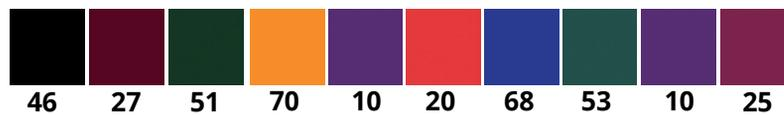

Match Mates® Combination Kit with a 3M™ Littmann™ Lightweight II S.E. Stethoscope

The Lightweight II S.E. Combination Kit includes the MABIS specially designed sphygmomanometer with calibrated nylon cuff and easy-to-read gauge with a Lifetime Calibration Warranty.

Colors: 46-Black and 27-Burgundy



Match Mates® Combination Kit with a 3M™ Littmann™ Classic II S.E. Stethoscope

Each features a MABIS brand specially designed professional aneroid sphygmomanometer plus a color-coordinated Classic II S.E. stethoscope. The coordinating adult size cuff is made of comfortable nylon and the precision gauge includes a Lifetime Calibration Warranty.

Colors: 46-Black, 27-Burgundy, 10-Purple, 18-Navy, 51-Hunter Green

Black 261-513-46 \$131.41
Burgundy 261-513-27 \$131.41
Purple 261-513-10 \$131.41
H.Green 261-513-51 \$131.41

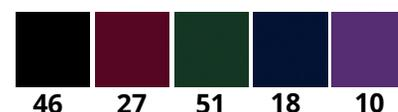

Medic-Kit™

The Medic-Kit5 features a chrome plated, German-crafted palm aneroid gauge, backed by a Lifetime Calibration Warranty, and comes complete with Adult, Infant, Child, Large Adult, and Thigh cuffs. The Medic-Kit3 has all the features of the Medic-Kit5 but comes with only three cuffs (Adult, Child, and Lg. Adult).

Medic-Kit3	\$129.07	Medic-Kit5	\$137.70
Blue	269-102	Blue	269-100
Orange	269-103	Orange	269-101



Disposable Single-Patient Use Sphygmomanometers

Designed to reduce the spread of infection, the MABIS Single-Patient Use Aneroid Sphygmomanometer combines a reliable, yet economical aneroid gauge with a disposable bulb and valve assembly and the Mabis Single-Patient Use Blood Pressure Cuff. 5 per box

Adult, Yellow	264-286	\$109.93
Adult, White	264-287	\$98.43
Large Adult, White	264-290	\$115.07



Legacy Wall Mounted Clock Aneroid Sphygmomanometers

The Legacy wall mounted clock aneroid sphygmomanometer is designed for easy use in the hospital, clinic, or ambulance. The extra large blue EZView™ faceplate with luminescent dial, numerals, and needle allow easy readability in the most demanding situations, including low level lighting conditions, provided the unit has been exposed to light prior to use. Special mounting bracket allows unit to swivel for easy readings. A built-in cuff storage space eliminates the need for a separate cuff storage basket. The unit comes complete with 8 foot coiled tubing, deluxe calibrated blue nylon cuff, and a deluxe air release valve. Includes all necessary mounting hardware. This unit is covered by a Ten Year Calibration Warranty and Five Year Warranty on the inflation system.



Wall Mounted **264-206 \$108.80**

Legacy Mobile Clock Aneroid Sphygmomanometer

The Legacy floor clock aneroid sphygmomanometer is designed for easy use in the hospital, nursing home, or clinic. The extra large blue EZView™ faceplate with luminescent dial, numerals, and needle allow easy readability in the most demanding situations, including low level lighting conditions, provided the unit has been exposed to light prior to use. Heavy base design makes the unit easy to move, while providing stability to prevent tipping. The height is easily adjustable to fit the needs of the individual user. A built in cuff storage area eliminates the need for a separate cuff storage basket. The unit comes complete with 8 foot coiled tubing, deluxe calibrated blue nylon cuff, and a deluxe air release valve. Latex-Free inflation system made from the finest neoprene available, and is covered by a Five Year Warranty. This unit is covered by a Ten Year Calibration Warranty.



Legacy Mobile **264-306 \$218.28**

Replacement Cuffs One Tube Bladders



Color:
80-Brown, 67-Blue, and 70-Orange

Nylon Cuff with One Tube

Infant	276-5CL	\$19.34
Child	276-4CL	\$14.07
Adult	276-3CL	\$24.50
Large Adult	276-2CL	\$19.35
Thigh	276-1CL	\$27.41



Replacement Cuffs Two Tube Bladders



Color:
18-Blue, 46-Black, and
70-Orange

Colors for Adult Size Only:

27-Burgundy, 20-Red,
25-Magenta, 53-Teal,
10-Purple, 68-Royal Blue, and
51-Hunter Green

Nylon Cuff with Two Tubes

Infant	275-5CL	\$19.34
Child	275-4CL	\$19.50
Adult	275-3CL	\$24.50
Large Adult	275-2CL	\$14.90

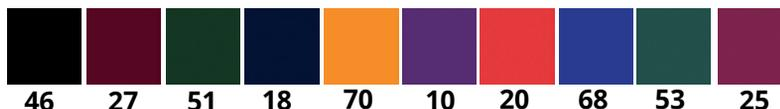

Latex-Free Replacement Cuffs with Bladders

Blue Nylon Cuff with One Tube

Infant	272-206	\$19.34
Child	272-207	\$19.50
Adult	272-205	\$24.50
Large Adult	272-208	\$35.33
Thigh	272-209	\$43.24

Black Nylon Cuff with Two Tubes

Infant	272-201	\$13.60
Child	272-202	\$14.46
Adult	272-200	\$15.30
Large Adult	272-203	\$18.63
Thigh	272-204	\$41.28



Replacement Bladders

One Tube

Infant	272-151	\$8.40
Child	272-152	\$7.11
Adult	272-150	\$7.11
Thigh	272-154	\$16.30

Two Tubes

Adult	272-121	\$7.11
Large Adult	272-111	\$11.15
Thigh	272-101	\$16.30



Latex-Free Replacement Bladders

In response to an increasing occurrence of allergic reactions to latex and a corresponding increase in the demand for items that are Latex-Free, we are pleased to introduce our comprehensive line of Latex-Free products. Latex-Free inflation systems use only the finest neoprene available. Neoprene has the added benefit of being more resistant to environmental and chemical factors that generally reduce the life expectancy of traditional latex products. Latex-Free inflation systems, parts and accessories made with neoprene components are backed by a Five Year Warranty.

Two Tubes

Infant	272-216	\$10.96
Child	272-217	\$11.66
Adult	272-215	\$13.00
Large Adult	272-218	\$15.56
Thigh	272-219	\$17.82





Connectors

- 1 Piece Plastic 277-310 \$0.89
- 2 Piece Plastic 277-311 \$3.33
- 2 Piece Metal 277-312 \$8.17

Air Release Valves

- Standard 277-210 \$4.00
- Deluxe 277-211 \$5.50

Bulbs

- Bulb Only 277-410 \$3.93
- with Standard Valve 277-411 \$8.40
- with Deluxe Valve 277-412 \$7.70

Coil Tubing

- 4 Foot 277-109 \$11.26

Gauges

- Econo 277-010 \$10.20
- Deluxe 277-022 \$25.00
- Deluxe, Blue 277-023 \$14.40
- Palm with bulb 277-027 \$58.62

Gauge Parts and Accessories

- Ring for Standard Gauge 279-100 \$3.11

Latex-Free Bulbs

- with Standard Valve 272-221 \$4.80
- with Deluxe Valve 272-222 \$7.60

Latex-Free Coil Tubing

- 8 Foot 272-225 \$14.92



Connectors



1 Piece



2 Piece



2 Piece

Bulbs



Bulb Bulb with Valve

Air Release Valves



Standard



Deluxe

Gauges

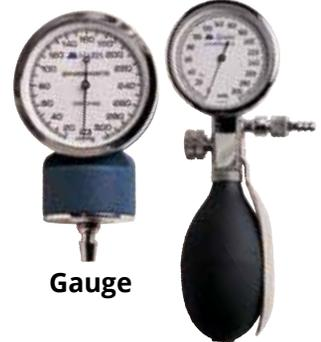

Gauge

Palm Gauge

Gauge Guards



Blue

Black

Coil Tubing



Latex-Free

Bulb with Valve



Coil Tubing



Replacement Cuffs

Blue Nylon

- Infant 273-467 \$10.09
- Adult 273-267 \$11.90
- Large Adult 273-167 \$13.17
- Thigh 273-067 \$17.68





Advantage Semi-Automatic Blood Pressure Monitor

Compact, and easy-to-use The Advantage Semi-Automatic Blood Pressure Monitor measures systolic, diastolic pressure, and pulse. Manual inflation. Self adjusting latex-free D-Bar cuff and automatic deflation valve with auto off.

Blood Pressure Monitor

Adult Cuff **264-501 \$31.98**
 Large Adult Cuff **264-516 \$62.85**



Advantage 6013 Automatic Blood Pressure Monitor

Automatic inflation/deflation, extra large digital display and state-of-the-art oscillometric technology make this unit extremely accurate, reliable, and easy to use. Nine pre-set inflation settings fit the range of all users. Memory feature allows the user to recall the last reading. The unit includes detailed operating instructions and is backed by a Two-Year Warranty.

Blood Pressure Monitor

Adult Cuff **264-502 \$71.25**
 Large Adult Cuff **264-515 \$59.99**



Advantage Digital Wrist Blood Pressure Monitor

The feature rich Advantage Digital Wrist Blood Pressure Monitor is portable, economical & easy to use. This monitor recalls the last 90 readings and has an auto off function providing a longer product life. Features ADC's patented Smart Logic™ Technology that determines the ideal inflation level to measure systolic, diastolic pressure and pulse. The wrist cuff is latex free and fits 5" to 7" wrists. Includes a 5 year warranty and operates on 2 AAA batteries that are included. Also included with the ADC Advantage™ 6015 Digital Wrist Blood Pressure Monitor is a compact storage case.

Blood Pressure Monitor 264-500 \$39.99



Advantage Digital Wrist Blood Pressure Monitor

Features:

- 60-reading memory storage
- Date and time stamp
- Irregular Heartbeat Detection
- WHO indicator
- Includes: Cuff (Choose size)

Specifications:

- Color: White / Light Blue
- Standard cuff: 11 3/4" - 16 1/2"
- Large cuff: 16 1/2" - 18 7/8"

Clip Style Fingertip Pulse Oximeter

Lightweight at less than 2 oz. The unit comes with a convenient lanyard. The large color display is adjustable in 2 positions and is easy to read day or night.



\$44.95

Pulse Oximeter 207-427 \$44.95 disc

Go2 Achieve Fingertip Pulse Oximeter

Accurately monitors oxygen saturation. Operates with one AAA battery - approximately 2,400 spot checks. Drop tested durability. Water ingress protection. Finger size range 0.3" to 1.0"



Pulse Oximeter 207-432-CL \$114.29

Onyx 9500 Fingertip Pulse Oximeter

Pulse oximetry has never been this easy and affordable. Incorporating the electronics and sensor into one unit - the Onyx provides a cost effective solution for spot-checks and short-term monitoring.

Onyx 9500

Pulse Oximeter **207-400 \$277.63 DISC.**

Accessories

- Gripping Insert **207-451 \$2.22**
- Lanyard Cord and Lock, Black **207-452 \$3.33**
- External Spring **207-450 \$5.60**
- Carrying Case, Clip, Black **207-456 \$20.83**



\$277.63

8500 Series Handheld Pulse Oximeter

The 8500 Digital Handheld Pulse Oximeter provides a simple universal tool for patient monitoring - from spot checks to continuous monitoring. Additionally, the versatility of the 8500 Series makes it a cost-effective solution for many monitoring situations.

8500 Series

with 800044, 1m Cable **207-410 \$450.62**

Accessories

- Mounting Bracket **207-476 \$50.00**
- Mounting Bracket with Pole **207-478 \$151.32**
- Table Top Stand **207-477 \$50.00**
- Rubber Bumper **207-475 \$57.75**
- Carrying Case, Black **207-473 \$57.75**
- Carrying Case, Blue **207-474 \$57.75**
- (holds oximeter, printer and accessories)
- Serial Cable, Memory **207-481 \$97.14**
- Thermal Paper, 20 Rolls **207-471 \$45.26**
- Data Mngt Software for Oximetry Screening **207-483 \$335.53**



\$450.62

PalmSAT 2500 Handheld Pulse Oximeter

Proven Performance in Real World Applications. PalmSAT - the next generation in Handheld Pulse Oximetry - is a small, yet versatile digital pulse oximeter designed to accurately assess oxygen saturation and pulse rate.

PalmSAT 2500

with 8000AA, 1m Cable **207-405 \$533.33**

Accessories

- Carrying Case, Blue **207-461 \$57.75**
- Extension Cable, 3 Foot **207-464 \$52.50**
- Extension Cable, 9 Foot **207-465 \$84.29**
- Serial Cable, Memory **207-481 \$97.14**
- Power Supply **207-463 \$100.00**
- Charge Stand, include Batteries **207-460 \$263.16**
- Data Management Software for Oximetry Screening **207-483 \$335.53**



\$533.33

Plastic Glove Box Holder



Plastic Glove Box Holder

10¾"x3¾"x3½" **209-022 \$20.67**

Wire Glove Box Holder



Wire Glove Box Holder

11¾"x3¾"x4¼" **209-023 \$20.67**

Vinyl Examination Gloves (Lightly-Powdered & Powder-Free)

Gloves have a smooth finish and soft feel. Durable with tactile sensitivity. Can be used in the Medical, Dental, Laboratory, Industrial and Food Service applications. Meets or exceeds ASTM Standard D-5250-92. Layer packed allows for easy dispensing, reduces wrinkles and clumping. Ambidextrous gloves fit either hand. Packed: 100 gloves per Easy Open Dispenser Box



Lightly Powdered Examination Gloves

272-251-SZ \$5.00 box

Powder Free Examination Gloves

272-259-SZ \$5.58 box



10 Second Thermometer

Temperature measurements are displayed within 10-seconds. Waterproof feature allows for easy cleaning. Features memory recall of last reading, large easy-to-read display, peak temperature tone and auto shut-off. Can be used orally, rectally or under the arm. Comes with storage case and Limited Lifetime Warranty.

Thermometer

10-Second **274-113 \$7.32**

Probe Covers **274-102 \$5.86 box of 100**

10 Second Flexible Tip Thermometer

Temperature measurements are displayed within 10-seconds. The flexible tip conforms to the shape of the mouth making readings more comfortable and safe. Waterproof feature allows for easy cleaning. Features memory recall of last reading, large easy-to-read display, peak temperature tone and auto shut-off. Can be used orally, rectally or under the arm. Comes with storage case.

Thermometer

10-Second **274-144 \$8.95**

Probe Covers **274-102 \$5.86 box of 100**



Deluxe Digital Thermometer

A fast, 60-second readout is just one of the many features of this large display digital thermometer. Includes beeper function to indicate peak temperature, memory recall of last reading, auto shut-off and waterproof feature for easy cleaning.

Thermometer 274-136 \$6.43



MediBeads Moist Heat Wraps

Features:

- Microwave activated in minutes, no wires, cords or boiling water
- Deep penetrating moist heat
- Washable and Reusable
- Wrap stays in place during treatment
- Safe: Timed release heat. MediBeads will not support mold, bacteria or fungi growth

MediBeads

A. Pad, 9"x12"	278-301	\$17.92
B. Neck Rest, 10½"x14"	278-303	\$17.42
D. Therapy Wrap, 7"x14"	278-306	\$21.58
E. Joint Wrap, 6"x8"	278-309	\$18.33
F. Sinus Wrap, 7"x11"	278-304	\$11.42
G. Hand Wrap, 5½"x7"	278-307	\$12.50
H. Carpal Cuff, 4½"x4½"	278-308	\$10.33
I. Foot Wraps (fits up to mens size 12)	278-310	\$45.00 a pair

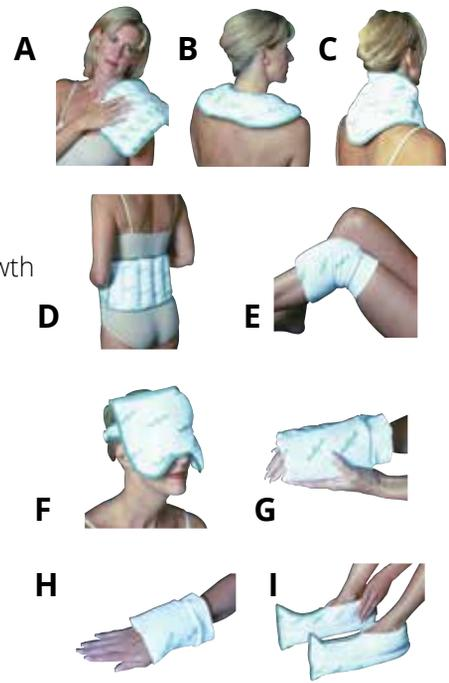

Therabath

Paraffin is able to absorb & retain a great amount of heat. The Therabath takes advantage of paraffin's heat-retaining capacity in a simple process called heat transfer. Very simply, the heat that goes into melting the paraffin is released when it solidifies into a custom-fit "glove", transferring the heat deep into the affected area. Each dip in a Therabath delivers a layer of fast acting heat therapy-without drugs!

Paraffin Therapy Bath

Scented **317-100-SC \$157.89 DISC.**
 Scent Choices: 97-Peach, 15-Lavender, 55-Fresh Melon Burst, 70-Orange Velvet, 57-Wintergreen, 94-Scent Free

TheraBath Refill Paraffin Wax 6 lbs

97-Peach, 15-Lavender, 55-Fresh Melon Burst, **317-104-SC \$26.50 DISC.**
 70-Orange Velvet, 57-Wintergreen, 94-Scent Free



Mitt and Boot Liners

Therabath[®]
 PROFESSIONAL GRADE
 PARAFFIN BATH **PRO**

Physical Therapy Putty

Designed for exercise and strengthening fingers, hands and wrists. Moldable silicone material will not harden.

Therapy Putty, 2 oz.

Soft	199-903	\$5.85
Medium	199-904	\$5.85
Firm	199-905	\$5.85



Drive Medical PainAway Wireless TENS

- › Can be used for chronic and acute pain on most areas of the body.
- › Wireless design with rechargeable remote and receivers – no batteries to purchase.
- › Sleek LCD Remote controls up to 3 wireless receivers with ‘snap connectors’ to electrodes.
- › Long lasting electrode pads for up to 30 uses.
- › Dual Channel system delivers twice the power as conventional TENS units.
- › Provides constant current throughout each treatment.
- › **Amplitude range:** maximum: 50V-90V; minimum:0-10V(1 KO load).
- › **Frequency:** 1.2-60Hz(±15%).
- › **Pulse:** 100µS(±30%).
- › Comes complete with LCD Remote Control, Two Wireless Receivers, One Large Long Lasting Back Electrode pad, Two 2"x3" Long Lasting Electrode Pads, Recharging Kit, Quick Start Guide and Instruction Manual.



Drive Medical PainAway Wireless TENS **276-820** **\$59.95 DISC.**

Portable Dual Channel TENS Unit with Electrodes and Carry Case

- › Comes complete with carrying case, 2 lead wires, 9-volt battery, 1 package of 4 pre-gelled electrodes and operating manual
- › Designed for rehabilitation and physical therapy
- › Dual isolated channels
- › For chronic, acute and postoperative pain
- › Intensity control is adjustable from 0-80 mA, 500 load
- › Metal belt clip
- › **Mode selector:** Constant
- › **Pulse frequency:** adjustable from 2-150 Hz
- › **Pulse width:** is adjustable from 40-250 micro-seconds
- › **Wave form:** asymmetrical, bi-phase, square pulse



Portable Dual Channel TENS Unit **276-704** **\$33.50**

PMI E-Stim 2500 Dual Channel 3-Mode TENS Unit w/Timer - Complete System

- › **Channels:** Dual, isolated between channels
- › **Modes:** Burst, Constant, Modulation
- › **Pulse Width:** 60-250 microseconds, adjustable
- › **Pulse Amplitude (intensity):** 0 to 80 mA each, adjustable (500 ohm load)
- › **Pulse Frequency:** Variable, 2-150 Hz adjustable
- › **Timer:** 30 Min, 60 Min, or Constant
- › **Modulation Mode:** Pulse width automatically varies is cyclical pattern over an interval of nominally 4 seconds
- › **Burst Mode:** 7 pulses per burst, 2 bursts per second, 100Hz internal frequency of burst
- › **Battery Life:** 70 hour average (alkaline)
- › **Waveform:** Modified square wave with zero net direct current



E-Stim 2500 3 Mode TENS Unit with Timer **276-802** **\$42.74**

PMI E-Stim 2500 Dual Channel 3-Mode TENS Unit w/Timer - Complete System

- › **Channels:** Dual, isolated between channels
- › **Modes:** Burst, Constant, Modulation
- › **Pulse Width:** 60-250 microseconds, adjustable
- › **Pulse Amplitude (intensity):** 0 to 80 mA each, adjustable (500 ohm load)
- › **Pulse Frequency:** Variable, 2-150 Hz adjustable
- › **Timer:** 30 Min, 60 Min, or Constant
- › **Modulation Mode:** Pulse width automatically varies is cyclical pattern over an interval of nominally 4 seconds
- › **Burst Mode:** 7 pulses per burst, 2 bursts per second, 100Hz internal frequency of burst
- › **Battery Life:** 70 hour average (alkaline)
- › **Waveform:** Modified square wave with zero net direct current



E-Stim 2500 3 Mode TENS Unit with Timer **276-802** **\$42.74**

PMI Advantrode Elite Silver TENS Electrodes White Foam

Round, 2"	276-739	\$4.79 pack of 4
Square, 2" x 2"	276-740	\$4.79 pack of 4
Oval, 2" x 4"	276-742	\$6.15 pack of 4
Rectangular, 1.75" x 3.75"	276-743	\$6.03 pack of 4
Rectangular, 3" x 5"	276-745	\$4.85 pack of 2

PMI Advantrode Elite Silver TENS Electrodes Tan Spunlace

Round, 2"	276-751	\$4.79 pack of 4
Square, 2" x 2"	276-752	\$4.79 pack of 4
Rectangular, 1.75" x 3.75"	276-754	\$6.03 pack of 4
Oval, 2" x 4"	276-755	\$6.15 pack of 4

PMI Advantrode Elite Silver TENS Electrodes Tan Tricot

Round, 2"	276-767	\$4.79 pack of 4
Square, 2" x 2"	276-768	\$4.79 pack of 4
Rectangular, 1.75" x 3.75"	276-770	\$6.03 pack of 4
Oval, 2" x 4"	276-771	\$6.15 pack of 4
Rectangular, 3" x 5"	276-773	\$4.85 pack of 2

PMI Advantrode Elite Silver TENS Electrodes White Spunlace

Round, 2"	276-778	\$4.79 pack of 4
Square, 2" x 2"	276-779	\$4.79 pack of 4
Oval, 2" x 4"	276-781	\$6.15 pack of 4
Rectangular, 1.75" x 3.75"	276-782	\$6.03 pack of 4
Rectangular, 3" x 5"	276-784	\$4.85 pack of 2

PMI Advantrode Elite Skin-Friendly Blue Gel TENS Electrodes

Square, 1.75" x 1.75"	276-788	\$8.12 pack of 4
Square, 1.75" x 1.75" with Snap Tan Tricot	276-789	\$8.74 pack of 4
Rectangular, 1.75" x 3.75" Tan Tricot	276-790	\$11.53 pack of 4
Rectangular, 1.75" x 3.75" with Snap Tan Tricot	276-791	\$12.57 pack of 4
Rectangular, 3" x 5" Tan Tricot	276-792	\$11.84 pack of 1

PMI Advantrode Essential-Economical Carbon Film TENS Electrodes

Round, 2" White Cloth	276-793	\$4.09 pack of 4
Square, 2" x 2" White Cloth	276-794	\$4.09 pack of 4
Rectangular, 1.75" x 3.75" White Cloth	276-795	\$5.24 pack of 4
Oval, 2" x 4" White Cloth	276-806	\$5.27 pack of 4
Round, 3" White Cloth	276-807	\$6.16 pack of 4

PMI Advantrode Elite Back Therapy Backlap TENS Electrodes

Rectangular, 5" x 8" White Foam Butterfly	276-796	\$5.15 pack of 4
Rectangular, 5" x 8" White Foam	276-798	\$5.00 pack of 4
Rectangular, 13" x 1.5" White Foam	276-799	\$6.05 pack of 1

**Please call Customer Service for other available sizes
TOLL FREE: 800.328.5343**

PMI Electrode Current Dispersion

- The unique manufacturing processes and materials used in PMI electrodes provide a uniform current dispersion throughout the desired treatment site of each electrode. This uniform current dispersion provides the maximum treatment to the entire electrode surface.
- A leading brand electrode and a PMI electrode are placed on a "Current Dispersion Meter". An electrical current is passed through each electrode for a period of 60 seconds. The electrical voltage output is identical for each electrode
- The PMI electrode displays optimal current dispersion while the leading brand electrode has limited dispersion around the lead wire.

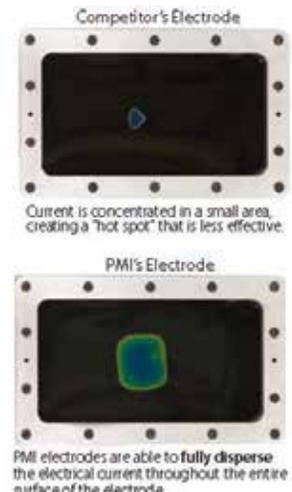
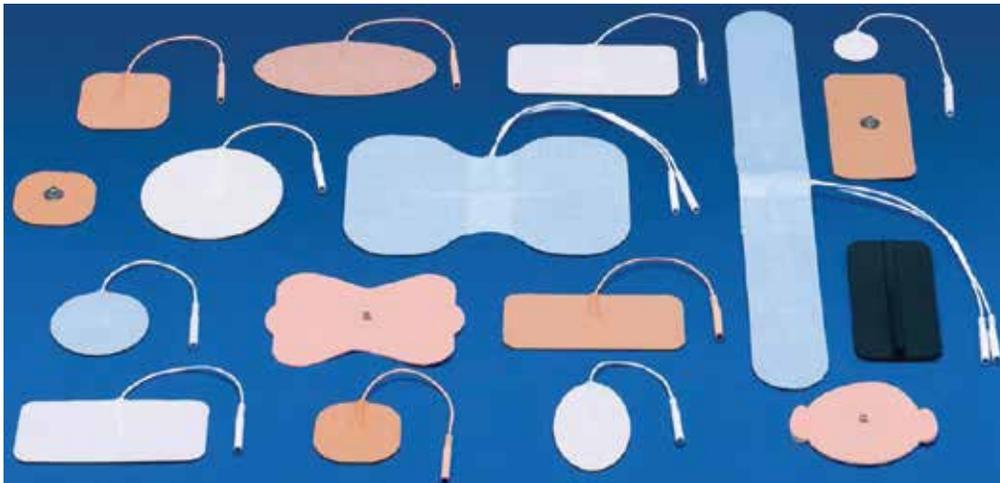

Cylinder Wrenches



Wrenches

Plastic	311-536	\$1.13
Plastic with Security Chain	311-537	\$3.30
Metal	311-534	\$1.98
Metal with Security Chain	311-535	\$3.95

Liter Meter

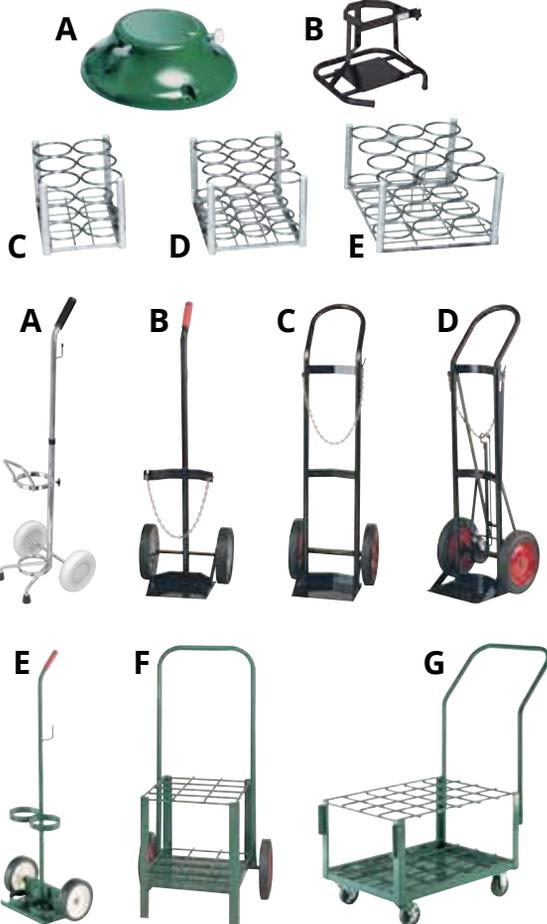

Cylinder Stands and Carts

Cylinder Stand

A. Holds 1 C, D or E Tank	311-658	\$39.05
B. Holds 1 M or M60 Tank	311-657	\$61.00
C. Holds 6 C, D or E Tanks	311-659	\$45.82
D. Holds 12 M6 (B) Tanks	311-660	\$61.08
E. Holds 12 C, D or E Tanks	311-661	\$62.10

Cylinder Carts

A. Holds 1 D or E Tank	311-234	\$25.50
B. Holds 1 M60 or M Tank	311-650	\$64.00
C. Holds 1 M60, M or H Tank	311-652	\$152.53
D. Holds 1 M60, M or H Tank	311-653	\$209.21
E. Holds 2 D or E Tanks	311-651	\$55.00
F. Holds 12 D or E Tanks	311-655	\$171.32
G. Holds 24 D or E Tanks	311-656	\$237.63

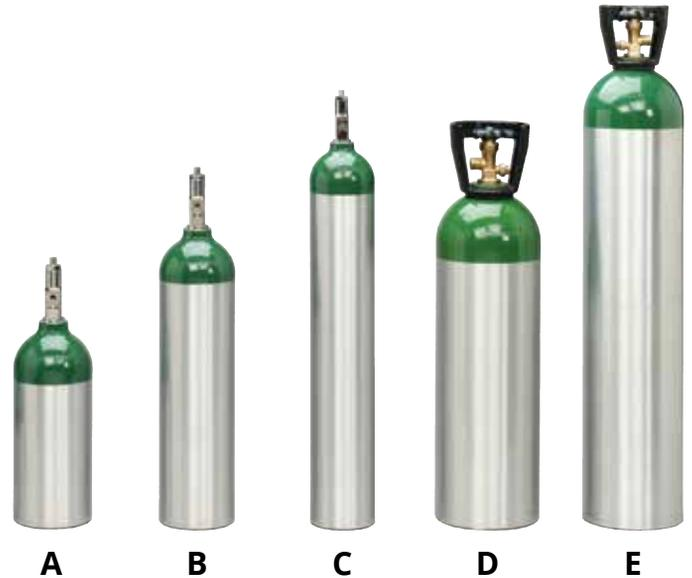

Aluminum Oxygen Cylinders

Features:

- › Aluminum cylinders are 40% lighter than steel
- › Cylinders are cleaned for medical oxygen service
- › Safety paint protects cylinder sidewall and provides heat detection
- › Cylinder finish is easy to clean and maintain
- › Straight thread design eliminates thread damage and provides positive seal

A. M9 (C)	10½"x4½"
3.5 lbs, 246 liters, 2015 psi	
Toggle Valve CGA-870	311-614 \$73.15
B. D	16"x4½"
4.9 lbs, 425 liters, 2015 psi	
Toggle Valve CGA-870	311-617 \$73.21
C. E	25"x4½"
7.3 lbs, 679 liters, 2015 psi	
Wrench Valve CGA-870	311-619 \$84.54
D. M60	23½"x7¼"
22.5 lbs, 1699 liters, 2216 psi	
Spigot Valve CGA-540	311-621 \$205.91
E. M	36¼"x8"
40.1 lbs, 3454 liters, 2216 psi	
Spigot Valve CGA-540	311-624 \$387.43

Compact Regulators



CGA-540 NUT and Nipple Inlet and Hose Barb Outlet Connections

Click Style Regulators

Features:

- › Aluminum body with brass inlet chamber
- › Tested to CGA standards which include ignition testing
- › Dial-in flow control
- › Maximum inlet pressure 3000 psi
- › Sintered filter for additional safety and to extend regulator life
- › Internal reseating relief valve protects against over-pressurization
- › 1½ diameter gauge
- › Designed for pediatric, homecare, hospital and emergency applications

Compact Regulator with CGA-540 Nut and Nipple Inlet and Hose Barb Outlet Connections

15 psi, Flow Settings $\frac{1}{64}$, $\frac{1}{32}$, $\frac{1}{16}$, $\frac{1}{8}$, $\frac{1}{4}$, $\frac{1}{2}$, $\frac{3}{4}$, 1, 1½ and 2 LPM	311-401	\$59.70
50 psi, Flow Settings $\frac{1}{4}$, $\frac{1}{2}$, 1, 2, 3, 4, 6, 8, 10 and 15 LPM	311-402	\$45.68
50 psi, Flow Settings $\frac{1}{2}$, 1, 1½, 2, 2½, 3, 4, 5, 6 and 8 LPM	311-404	\$45.68

Compact Regulator with CGA-870 Yoke Inlet and Hose Barb Outlet Connections

15 psi, Flow Settings $\frac{1}{64}$, $\frac{1}{32}$, $\frac{1}{16}$, $\frac{1}{8}$, $\frac{1}{4}$, $\frac{1}{2}$, $\frac{3}{4}$, 1, 1½ and 2 LPM	311-406	\$68.57
50 psi, Flow Settings $\frac{1}{4}$, $\frac{1}{2}$, 1, 2, 3, 4, 6, 8, 10 and 15 LPM	311-407	\$45.68
50 psi, Flow Settings $\frac{1}{2}$, 1, 1½, 2, 2½, 3, 4, 5, 6 and 8 LPM	311-409	\$48.77
50 psi, Flow Settings $\frac{1}{2}$, 1, 2, 3, 4, 6, 8, 10, 15 and 25 LPM	311-410	\$45.68

Extended Regulator with CGA-540 Nut and Nipple Inlet and DISS 1240 Outlet Connections

50 psi, Flow Settings $\frac{1}{4}$, $\frac{1}{2}$, 1, 2, 3, 4, 6, 8, 10 and 15 LPM	311-412	\$39.98
---	----------------	----------------

Extended Regulator with CGA-870 Yoke Inlet and DISS 1240 Outlet Connections

50 psi, Flow Settings $\frac{1}{4}$, $\frac{1}{2}$, 1, 2, 3, 4, 6, 8, 10 and 15 LPM	311-418	\$49.50
---	----------------	----------------



CGA-870 Yoke Inlet and Hose Barb Outlet Connections

Extended Regulators



CGA-870 Yoke Inlet and Hose Barb Outlet Connections



CGA-870 Yoke Inlet and DISS 1240 Outlet Connections



Features:

- › Regulator and Pneumatic conserving device combined into one unit
- › Conserving ratios up to 3:1
- › LPM 1, 1½, 2, 2½, 3, 3½, 4, 4½, 5, 5½ and 6
- › Continuous flow available on all flow settings
- › Dial-in flow control
- › Maximum inlet pressure 3000 psi
- › Sintered filter for additional safety and to extend regulator life
- › Internal reseating relief valve protects from over-pressurization
- › 1½" diameter gauge.

Oxygen Conserver **311-400** **\$179.54**



Power Neb Ultra Nebulizer

Built in neb kit holder for hands free use. Comes complete with disposable neb kit. Delivers consistent particle size of <5 microns and fast treatment times. One of the smallest economy neb compressors available today at only 3.2 pounds.

Power Neb Nebulizer 207-279 \$31.49



Voyager™ Pro

The Voyager™ Pro is a compact and lightweight portable nebulizer which utilizes silent vibrating mesh technology to deliver treatment times in less than 10 minutes for most medications

Voyager Pro 207-280 \$93.73



JetNeb Plus Nebulizer

Inspiratory valve delivers more medication. Expiratory valve wastes less medication. Maximum particle size of 3.4 µm. 92.6% of medication is converted into fine mist. Includes mouthpiece and air tube.

JetNeb Plus 12/cs 207-276 \$97.18

POLARIS® CPAP

INVACARE POLARIS (TM) CPAP The Invacare Polaris(TM) Continuous Positive Airway Pressure (CPAP) device is designed to make life easier for the patient, as well as the clinician. That is because it has one-button operation, low noise level, and light-weight compact design offers the patient maximum convenience. At the same time, its simple set-up, reliable performance, and compliance monitoring features make the Polaris the clear choice for the clinician. It is obvious the innovative Polaris is the perfect solution to meet patient needs.

Specifications:

Operating Pressure: 4-20 cm H2O 1 cm H2O increments
 Ramp: 5,10,20 & 30 minutes
 Power: Input Supply: 240 Volts, 60 Hz
 Air Filter: 45-60 ppi foam, reusable

Polaris EX CPAP with Carrying Case

with SoftX and Polaris EX EZ-Fill Heated Humidifier with Air Tubing, IQ Gel Cushion Mask, Connector Tubing and Large Headgear Strap

207-202 \$488.35
 207-188 \$378.75

Polaris CPAP with Carrying Case

with Air Tubing
 with Air Tubing, IQ Gel Cushion Mask, Connector Tubing and Large Headgear Strap

207-197 \$224.84
 207-198 \$276.63



NasalFit EZ CPAP Mask

The NasalFit Deluxe EZ CPAP Mask has a soft silicon cushion, comfortable forehead plate with silicon pad, and a 360° rotational elbow, which are designed to increase comfort, and mask stability.

Small 207-274 \$43.85
Medium 207-277 \$43.85
Large 207-278 \$43.85



PillowFit Nasal CPAP System

The PillowFit Deluxe maximizes compliance by offering superior comfort with minimal facial contact during PAP therapy in a lightweight, easy to use and assemble design.

With Headgear 207-272 \$69.95
Without Headgear 207-273 \$70.40



IQ Gel Cushion Mask

TKO Turning Knob Operator

People with hand disabilities will benefit from this turning device. It will work on any non-round control knob or appliance handle. Measures 2¼" in diameter but will grip larger irregular-shaped knobs.



Adjustable Gripping Tongs

Jaws adjust from zero to 3 1/8".

Multi-Use Adjustable Tongs

- > Turns Knobs
- > Pulls Out Plugs
- > Opens Bottles, Jars or Vials
- > Picks up Pins, Nails or Coins



Gripping Tongs 275-142 \$73.95

One-Way Straw

Straws with one-way valves stay filled with liquid after removing from lips to eliminate sucking in of air from an empty straw. Straws can be cleaned. Each package includes one 10" and one 7" straw with ¼" holes.



Straw 275-122 \$15.15

Foam Tubing

Use to build up tool and utensil handles. Tubing has a slip resistant coating, does not absorb water, and is dishwasher safe up to 125°. Twelve-inch long tubing can easily be cut to any length with scissors.



Foam Tubing

- 6 Tan, ¼" I.D. and 1" O.D. 275-115 \$14.65
- 6 Red, 3/8" I.D. and 1 1/8" O.D. 275-116 \$14.65
- 6 Blue, 5/8" I.D. and 1 1/8" O.D. 275-117 \$14.65

Flexible Utensils



Ideal for evaluating self-feeding needs. Versatile utensils may be angled or positioned in a variety of directions. Foam handle is 1" in diameter and can be customized to fit a user's grip. Each utensil weighs only 4 oz. and measures 14" long. Clean with warm, soapy water.

Utensils \$19.65
Fork 275-113
Tablespoon 275-114

KEatery Weighted Utensils

KEatery Weighted Utensils are designed for those individuals afflicted with Parkinson's Disease, Ataxia, or other illness or injuries that cause tremors of the hands. The heavy weight of these utensils steady the persons' hand to allow them to eat. All 18/0 stainless steel construction and dishwasher safe. KEatery Weighted Utensils weigh an average of 7.2 - 7.5 ounces.



Utensils \$12.67
Fork 275-185
Knife 275-186
Teaspoon 275-187
Soup spoon 275-188

Easy Risers

Strong: A set of four Easy Risers will support a 3,000 lb. van

Portable: Easy to take along when traveling

Sanitizable: Just throw them in the dishwasher

Adaptable: Easy Risers come in 2", 3", 4" and 5" heights with adapters. Simply select the height adjustment required and attach them to the base of the furniture

Affordable: A reasonable alternative to a lift chair or new furniture

Easy Risers \$24.97 set of 4

Four 3" 275-194





Giant-Face Playing Cards

Enlarged faces and print on these standard-size playing cards.

Playing Cards 275-111 \$9.95



Card Holder

Designed to be free standing on a table top or held in the hand. holds up to 15 cards. Set of 2.

Card Holder 275-139 \$11.17



Portable EZ-STEP

Features:

- › Reduce the height of each step by 50%
- › Reduce the range of motion of the knee and hip
- › Reduce muscle activity
- › Foster greater independence
- › Enjoy access to virtually any building with stairs
- › Affordable
- › Portable, take along when traveling



Lamp Switch

Fits most standard lamp threads.

Switch 275-105 \$10.60

Standard Assist Reacher

Adds 32" inches to arm to reduce stretching and bending when picking up objects. Ideal for individuals with limited hand strength. Ergonomically designed trigger for use with the whole hand. Jaws rotate 360°. Serrated jaws allow for secure grip. Lightweight aluminum construction. Limited 6 Month Warranty.

Standard Reacher

32"

275-129 \$15.50



Standard Reachers

High quality, durable aluminum is extremely lightweight. Shape of the serrated jaw and flexible foam rubber tip, which conforms to the contours of any object, work together to ensure a firm, secure grip. Hands remain comfortable on the ergonomically designed, trigger-action handle. Standard models feature a pulling lug that helps draw items toward the user. All models have a magnetic tip to retrieve small metal objects. Jaws open to 3" wide.

Reachers

26"

275-132 \$12.92

26" Folding

275-131 \$28.80

32"

275-130 \$25.05



Rubber Grip Reachers

Featherweight aluminum reacher with circular rubber tips provides a powerful and secure grip with delicate sensitivity. Easy-to-pull plastic handles with pistol grip action for comfortable holding and operating. The locking model has an automatic locking mechanism to hold the jaws securely around the object being retrieved. A flip of the thumb release lock. Optional wrist support easily conforms to the forearm with limited wrist and hand strength.

Reachers

30"

275-118 \$47.77

30" Locking

275-120 \$52.45



Dressing Aid Stick

Helps with all dressing or undressing activities. 27" stick is designed to reach zippers, laces, socks, etc.



Dressing Aid **275-134** **\$8.95**

Zip-It

Makes zipper use easy with a 4" hook that grasps and closes the zipper. Enables individuals to dress without assistance.

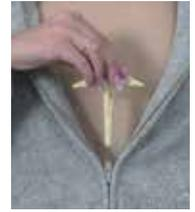

Zip-It **275-133** **\$18.23**

Pantyhose Aid

Made from soft plastic to shape into a tube and place into the pantyhose. Insert feet and pull cords. Cords can be cut or joined together. Requires two hands to use.



Pantyhose Aid **275-106** **\$27.95**

Sock and Stocking Aid

Socks or stockings are drawn over the flexible plastic core. For additional help in reaching, attach socks to garters on the aid and insert foot. Continued pulling brings hose over the heel and onto the calf. Not recommended for one-handed individuals.



Sock Aid **275-104** **\$12.95**

Ezy™ Sock Helper

The socks or stockings are simply stretched over the columns and toes are inserted. The continued motion pulls the sock all the way on, or stocking and panty-hose up to the knees for final positioning by pulling on the side handles. Three models assist in putting on socks, stockings and panty hose. These sturdy helpers are made of steel with smooth plastic coatings.

Sock Helper

- Single without Handles **275-155** **\$53.25**
- Single with Handles **275-147** **\$60.63**
- Double with Handles **275-148** **\$65.92**

Single without Handle

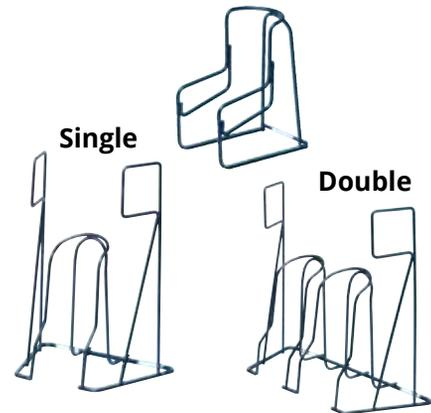

Button Hooks

These button hooks meet most buttoning needs. Ideal for those who lack fine motor coordination or have use of only one hand. Button Hooks are easy to use; simply slip wire hook through button hole, grab button with wire and pull button back through hole. Several styles available. Button Hooks with Zipper Pull, two aids in one. The hook answers buttoning needs. Zipper pull attaches to hard to handle zipper tabs, making it easier to zip. Adds leverage to small zippers.

Button Hook

- Rubber Handle **275-100** **\$14.85**
- Foam Handle **275-102** **\$16.43**

Button Hook with Zipper Pull

- Plastic Handle **275-101** **\$21.83**
- Rubber Handle **275-103** **\$18.68**

Button Hooks with Zipper Pull



Ocelco Heavy Duty Pill Crushers

NEW Quiet

Construction of the die-cast Metal Pillcrusher embodies chrome die-cast components and a stainless steel corrosion resistant receptacle. It's unparalleled strength and durability allow for years of simple and trouble free crushing. The Plastic Pillcrusher body is constructed of lightweight polycarbonate injection molded plastic, the receptacle fitting in both the handle and base are stainless steel to maximize power for crushing. Available in four decorative colors. Both metal and Plastic pillcrushers are backed by a two year conditional warranty against defects and workmanship.

Features:

- Easily reduces pills to powder
- Perfect for hospitals, nursing homes and pharmacies
- Mounts to med-carts, table tops, etc. with mounting base

Mounting Base for Metal or Plastic



\$64.95

New Changes mean a 50% Quieter Pill Crusher!



Pills crushed between two 3/4 oz. soufflé cups or the NEW 4" x 2" Sani-Safe Crush Bags

Rubber Base Pads reduce reverberation between Pill Crusher and Table Surface

Nylon Washers reduce reverberation between the Handle and Base

NEW Metal Pill Crusher		Reg.	Sale
Metal Pill Crusher	104-233	\$74.69	\$64.95
Mounting Base (Blk)	104-237	\$22.02	\$19.15



Place pills in paper cup, then place inside crusher.



Cover with second cup to prevent cross contamination.



Squeeze handles with only enough pressure to break the pill. Move the handle up and down lightly while rotating the cups.



Remove cups. Now you are ready for next use.



Plastic Pill Crusher	Reg.	Sale
Mauve 104-323	\$45.90	\$39.92
Black 104-346		
Teal 104-350	Blue 104-367	



Pill Ejector

Features:

- › No more frustration removing pills
- › Eject your pills smoothly from blister packs
- › Opens tough packages
- › Ideal for arthritic people
- › Small enough to travel with you
- › So easy to operate, anyone can use



Pill Ejector **Reg.** **Sale**
 104-701 \$8.28 \$7.20



Perforating Tip for Thick Foil/Paper Backing

For extra tough blister backings, perforate backing with wheel.



Place blister pack foil side down in ejector.



Squeeze together firmly and pill ejects into the cup.



Remove blister. Now you're ready for your next use.



Hand-Held Pill Crusher

The Hand-held Pillcrusher has a die-cast body with an enamel finish. The unique handle design makes the crushing process effortless. Pills are crushed in patented bags. Each crusher is sold with 50 bags.



Place the bag into the tub area on the lower half of the crusher.



Squeeze the two halves of the crusher together and make the initial crush.



Open the crusher and adjust the bag, then squeeze the two halves together again.

Features:

- › Turn pills to powder
- › Ideal for adults or children who can't swallow pills
- › Heavy Duty, industrial strength
- › Small enough to travel with you
- › Totally Silent Operation



\$18.95

Pill Crusher Hand Held **Reg.** **Sale**
 104-696 \$21.79 \$18.95

Uses 2 1/2" X 2" Sani-Safe Crush Bags



Pill Crusher Bags

Get the Most out of Your Medication!

Due to its patented technology, Ocelco's bag retains only a fraction of the medication compared to the rest.

Features:

- › Lowest Medication Retention after Crushing
 - › Does not imbed medication into the bag
 - › Ultra Thin and More Durable than the Competition
 - › 1/5th of the Weight of the Competition
 - › Save \$\$ on Shipping
 - › Replaces Souffle Cups with the Metal Pill Crusher
- Made in the USA



104-656 2 1/2" X 2" Roll of 100 **\$5.75**
104-661 4" X 2" Roll of 100 **\$5.75**

Color Curve Analysis:

Clearly shows Sani-Safe Crush Bags have a significant advantage over the competition.

The others use a softer, thicker poly plastic which allows for a significant amount of medication to imbed into the bag during crushing. Imbedded medication has a tendency to capture more of the medication in the bag resulting in reduced medicinal effectiveness.



3/4 oz. Souffle Cups

104-246 Case of 1,000 **\$16.65**
104-245 Case of 5,000 **\$71.67**



Pill Counter with Spatula

104-210 **\$8.33**



Pill Splitter

104-236 **\$4.17**



Pill Pod

104-222 **\$2.08**



Drink-A-Pill Glass

104-219 **\$1.48**



1oz. Measuring Cup

104-218 **\$14.65 500cs.**



Naugahyde Material



Nylon Material



Mesh Material



Web Material



PVC Products Color Options

Standard Mesh



Standard Solid Vinyl

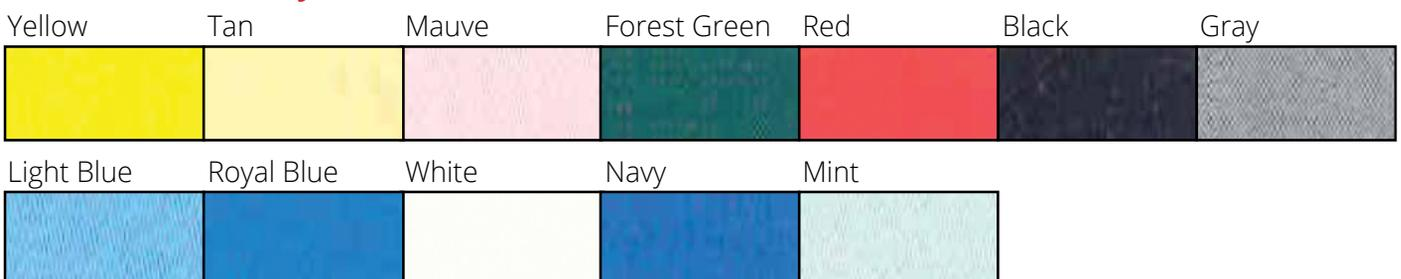

Now Featuring Online Ordering

Visit our Online Store
www.ocelco.com

Visit our NEW Online Store
www.WheelchairParts.com

Order Equipment & Parts Online

Don't Miss Out on
SALES and DISCOUNTS
only Offered Online



* After Registering Call
Customer Service To Change Your
Account To Wholesale Pricing
1-800-328-5343

Online Store Features:

- Cash Rewards -
- E-mail Specials -
- More Products -

Order Online and SAVE Money with Ocelco Cash Reward Points, See Website for More Details.
Internet Only Specials E-mailed Weekly, Not Receiving Them Call to be Added.
Products Updated and Added Daily.

The screenshot shows the Ocelco website homepage. At the top, there is a navigation bar with social media icons, a "LIVE HELP" section (M-F 8:00AM - 4:30PM CST) with the phone number (800)328-5343, a search icon, a shopping cart icon with the text "The cart is empty.", and a "Register/Login" link. Below the navigation bar is the Ocelco logo with the tagline "We're the Friendly People". The main navigation menu includes "HOME", "SHOP BY DEPARTMENT", "SPECIALS", "BEST SELLERS", "NEW ARRIVALS", and "SHOP BY BRAND". The main content area features a large banner image of a hand on a wheelchair wheel with the text "WHEELCHAIRS AND ACCESSORIES" and "Top brands and models at the best prices you will find anywhere!". Below the banner is a "FEATURED PRODUCTS" section with four product images: a silver and black wheelchair, a purple and white Ocelco battery, a metal hook, and a set of blue and white striped curtains.



We're The Friendly People

1111 INDUSTRIAL PARK ROAD
BRAINERD, MN 56401
WWW.OCELCO.COM

LOCAL 1-218-828-7788
TOLL FREE 1-800-328-5343
FAX FREE 1-866-829-9744



Compare & Save

Lowest Pricing Around

Serving Your Needs Since 1974

Presorted Standard
U.S. Postage
Paid
Ripon, WI
Permit No. 100

CHECK OUT OUR NEW WEBSITE

www.WheelchairParts.com



3 Position Recliner
Page 79

New Featured Products at Ocelco

Look for this featured product badge throughout the catalog for valued items that have excellent pricing.

Med Aire
8" Mattress
Page 96



Drive Manual
Patient Lifts
Page 114

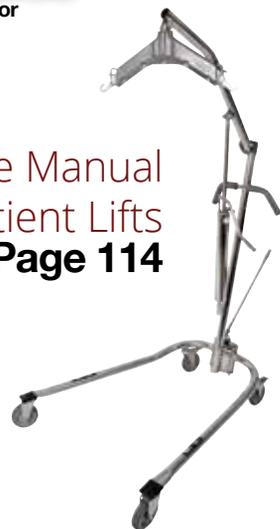

SALE 10% OFF
Pill Management Line



Ocelco Original Pill Crusher



Hand Held
Pillcrusher



Polycarbonate Pill Crusher



Pill Counter

Drive Medical PainAway
Wireless TENS
Page 146



LOG ON TODAY TO SAVE TIME AND MONEY WHEN YOU ORDER ONLINE

www.Ocelco.com - We're The Friendly People

CHECK OUT OUR NEW WEBSITE www.WheelchairParts.com